

Beechcraft
95

TRAVEL AIR

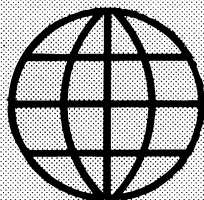

OWNER'S MANUAL

Published by
Parts and Service Operations
Beech Aircraft Corporation
Wichita, Kansas 67201

Founded in 1932 by Walter H. Beech

95-590014-1
November 15, 1957

95-590014-1A4
Revised March 15, 1968

IMPORTANT

(Please attach this Owner's Manual Supplement to the inside cover of the Owner's Manual or other suitable location which is readily available to the pilot.)

OWNER'S MANUAL

SUPPLEMENT

for

55, A55, B55, B55A, B55B, C55, C55A, D55, D55A, E55, E55A, 95, B95, B95A, D95A, E95.

The following information supersedes the information contained in the Owner's Manuals for the above listed airplanes.

1. Maximum usable fuel of each 25 gallon main tank is 22 gallons.
2. Maximum usable fuel of each 39 or 40 gallon main tank is 37 gallons.
3. Approximate reduction in range with full fuel due to change in usable fuel is:
 - a. 6% with the 142 gal. fuel system (all 55).
 - b. 7% with the 112 gal. fuel system (all 55's, and 95's).
 - c. 10% with the 78, 80 or 84 gal. fuel systems (all 95's).
4. On Models 95 and B95 Owners Manuals, reduce range by an additional 135 statute miles to account for climb and 45 minutes reserve at 45% maximum continuous power.

LIST OF EFFECTIVE PAGES

TOTAL NUMBER OF PAGES IN THIS PUBLICATION IS 171

<i>Page No.</i>	<i>Issue</i>	<i>Page No.</i>	<i>Issue</i>
*Title and A . . .	March 15, 1968	39	Original
Preface "A"	Original	40	March 20, 1958
i thru iii	November 10, 1958	41 thru 55	Original
iv	Original	56	November 10, 1958
1	November 10, 1958	57	Original
2 thru 3	Original	58	March 20, 1958
4 thru 4B	November 10, 1958	59	Original
5 thru 6	Original	60 thru 61	November 10, 1958
7	November 10, 1958	62 thru 79	Original
8 thru 10	Original	80	November 10, 1958
11	November 10, 1958	*81 thru 83	March 15, 1968
12	Original	84	August 25, 1967
13	March 20, 1958	85 thru 88	Original
14	Original	89	November 10, 1958
15	March 20, 1958	90 thru 92	Original
16 thru 18	November 10, 1958	93 thru 97	November 10, 1958
19	March 20, 1958	98 thru 106	Original
20	November 10, 1958	107 thru 108B. November 10, 1958	
21	March 20, 1958	109 thru 123	Original
22 thru 23	Original	124	March 20, 1958
24 thru 25	November 10, 1958	125 thru 133	Original
26	March 20, 1958	134 thru 135	November 10, 1958
27 thru 28	Original	136	March 20, 1958
29 thru 32	March 20, 1958	137 thru 157	Original
33 thru 36	Original	158	March 20, 1958
37	November 10, 1958	159	Original
38	March 20, 1958	160	November 10, 1958

*The asterisk indicates pages revised, added or deleted by the current revision.

THANK YOU . . .

for displaying confidence in us by selecting a BEECHCRAFT airplane. Our design engineers, assemblers, and inspectors have utilized their skills and years of experience to ensure that the BEECHCRAFT meets the high standards of quality and performance for which BEECHCRAFT airplanes have become famous throughout the world.

IMPORTANT NOTICE

This manual should be read carefully in order to become familiar with the operation of the airplane. Suggestions and recommendations have been made within it to aid in obtaining maximum performance without sacrificing economy. Be familiar with and operate the airplane in accordance with the Owner's Manual and FAA Approved Airplane Flight Manual and/or placards which are located in the airplane.

As a further reminder, the owner and operator should also be familiar with the Federal Aviation Regulations applicable to the operation and maintenance of the airplane, and FAR Part 91, General Operating and Flight Rules. Further, the airplane must be operated and maintained in accordance with FAA Airworthiness Directives which may be issued against it.

The Federal Aviation Regulations place the responsibility for the maintenance of this airplane on the owner and the operator, who should make certain that all maintenance is done by qualified mechanics in conformity with all airworthiness requirements established for this airplane.

All limits, procedures, safety practices, time limits, servicing, and maintenance requirements contained in this manual are considered mandatory for continued airworthiness to maintain the airplane in a condition equal to that of its original manufacture.

BEECHCRAFT Authorized Outlets will have recommended modification, service, and operating procedures issued by both the FAA and Beech Aircraft Corporation, which are designed to get maximum utility and safety from the airplane.

NOTE

Beech Aircraft Corporation expressly reserves the right to supersede, cancel, and/or declare obsolete, without prior notice, any part, part number, kit, or publication that may be referenced in this handbook.

It shall be the responsibility of the owner/operator to ensure that the latest revisions of publications referenced in this handbook are utilized during operation, servicing, and maintenance of the airplane.

WARNING

Use only genuine BEEHCRAFT or BEEHCRAFT approved parts obtained from BEEHCRAFT approved sources, in connection with the maintenance and repair of Beech airplanes.

Genuine BEEHCRAFT parts are produced and inspected under rigorous procedures to insure airworthiness and suitability for use in Beech airplane applications. Parts purchased from sources other than BEEHCRAFT, even though outwardly identical in appearance, may not have had the required tests and inspections performed, may be different in fabrication techniques and materials, and may be dangerous when installed in an airplane.

Salvaged airplane parts, reworked parts obtained from non-BEEHCRAFT approved sources, or parts, components, or structural assemblies, the service history of which is unknown or cannot be authenticated, may have been subjected to unacceptable stresses or temperatures or have other hidden damage, not discernible through routine visual or usual nondestructive testing techniques. This may render the part, component or structural assembly, even though originally manufactured by BEEHCRAFT, unsuitable and unsafe for airplane use.

BEEHCRAFT expressly disclaims any responsibility for malfunctions, failures, damage or injury caused by use of non-BEEHCRAFT approved parts.

Table of Contents

This Is Your Travel Air	Pages 1 to 12
Systems and Their Controls	Pages 13 to 34
Flying the Travel Air	Pages 35 to 84
Cruise Control	Pages 85 to 98
Loading Your Travel Air	Pages 99 to 104
Emergency Procedures	Pages 105 to 124
Keeping Your Travel Air New	Pages 127 to 160

Performance Graphs

Normal Take-Off	Pages 46, 47, 48, 49
Minimum-Run Take-Off	Pages 50, 51, 52, 53
Two-Engine Climb	Page 55
Best Rate-of-Climb Speed (two engines)	Page 55
Time to Climb	Page 57
Normal Landing	Pages 68, 69, 70, 71
Minimum-Run Landing	Pages 73, 74, 75, 76
Altitude Conversion	Page 91
Horsepower vs. Fuel Consumption	Page 92
Cruising Operation	Page 93
Range at Altitude	Pages 94, 95, 96, 97
Zero Thrust Graph	Page 107
Single-Engine Climb	Pages 108-109
Acceleration and Stop Distance	Page 110
Glide Distance	Page 124

General Specifications

ENGINES

Two Lycoming, 4 cylinder, O-360-A1A, rated at 180 hp @ 2700 rpm for all operations.

PERFORMANCE — TRUE AIRSPEED, STANDARD ALTITUDE

MAXIMUM CRUISING SPEED:

- (a) at 75% power (2450 rpm) 200 mph at 7500 ft.
- (b) at 65% power (2300 rpm) 195 mph at 10,500 ft.

HIGH SPEED AT SEA LEVEL

- (2700 rpm, full throttle) 210 mph

RATE OF CLIMB AT SEA LEVEL (rated power)

- Two engines 1360 fpm
- One engine 225 fpm

SERVICE CEILING (rated power) @ 4000 pounds

- Two engines (100 fpm) 19,300 ft.
- One engine (50 fpm) 6200 ft.

ABSOLUTE CEILING @ 4000 POUNDS

- Two engines 20,900 ft.
- Single engine (descending to level out at) 8,000 ft.

STALLING SPEED (Power Off), Flaps 33°, Gear Down 70 mph

MAXIMUM RANGE @ 165 mph 1410 miles on 112 gal.

ENDURANCE 8.75 hours

TAKE-OFF DISTANCE — (20° flap) Ground Run 850 ft.*

- Total Distance over 50 ft. 1025 ft.*

LANDING DISTANCE — (33° flap) Ground Run 590 ft.*

- Total Distance over 50 ft. 950 ft.*

*Take-off and landing performance based on Sea Level Standard Conditions.

TYPE

Four-place, high performance, all-metal, low-wing, twin-engine cantilever monoplane, with fully retractable tricycle landing gear, solid cabin top, and full complement of engine and flight instruments standard.

BAGGAGE

- Maximum 270 pounds — rear
- 270 pounds less equipment — front

WEIGHTS

- Gross Weight 4000 pounds
- Empty Weight 2570 pounds
- (Empty weight includes complete set of flight instruments; cabin heating and venti-

ating system, with windshield deicers; sound proofing; navigation, cabin, instrument and landing lights; unusable fuel and oil.)
 Useful Load 1430 pounds
 Available weight for people and baggage with full tanks, (standard fuel) 917 pounds

WING AREA AND LOADINGS

Wing Area 193.8 sq. ft.
 Wing Loading, at gross weight 20.6 lbs./sq. ft.
 Power Loading, at gross weight 11.1 lbs./hp

DIMENSIONS

Wing Span 37 ft. 10 in.
 Length 25 ft. 4 in.
 Height 9 ft. 6 in.

CABIN DIMENSIONS

Cabin Length 6 ft. 11 in.
 Cabin Width 3 ft. 6 in.
 Cabin Height 4 ft. 2 in.
 Passenger Door, size 36 in. x 37 in.
 Baggage Door, size 24 in. x 22 in.
 Baggage Compartments, size rear 16.5 cubic ft.
 Baggage Compartment, size front 13 cubic ft.

PROPELLER AND EQUIPMENT

Propeller — Hartzell, hydraulically controlled continuously variable pitch, diameter 72", with Woodard hydraulic governor, full feathering.

ENGINE EQUIPMENT (Per Engine)

Starter
 Generator
 Voltage Regulator
 Engine Primer
 Fuel Booster Pump
 Carburetor Air Filter
 Mufflers and Carburetor Heaters (stainless steel)
 Exhaust Manifolds (stainless steel)
 Vacuum Pump

FUEL AND OIL CAPACITY

Fuel Capacity in standard wing tanks 86 gal. (84 usable)
 Fuel Capacity with optional auxiliary wing tanks 113 gal. (112 usable)
 Oil Capacity 16 quarts

LANDING GEAR

Tricycle type with swiveling steerable nose wheel equipped with shimmy dampener. Beech air-oil struts on all wheels designed for smooth taxiing and to withstand the shock created by landing with a vertical descent component of over 600 feet per minute. Main tires 6.50" x 8" size; nose wheel tire 5.00" x 5" size. Wheels — Goodyear with single disc hydraulic brakes.

ELECTRICAL EQUIPMENT (24 Volt System)

Battery — 17 ampere-hour or 24 ampere-hour
 Electric motors for operating flaps and landing gear
 Electrically Operated Cowl Flaps
 Two 15-Amp. Generators or two 25-Amp. Generators

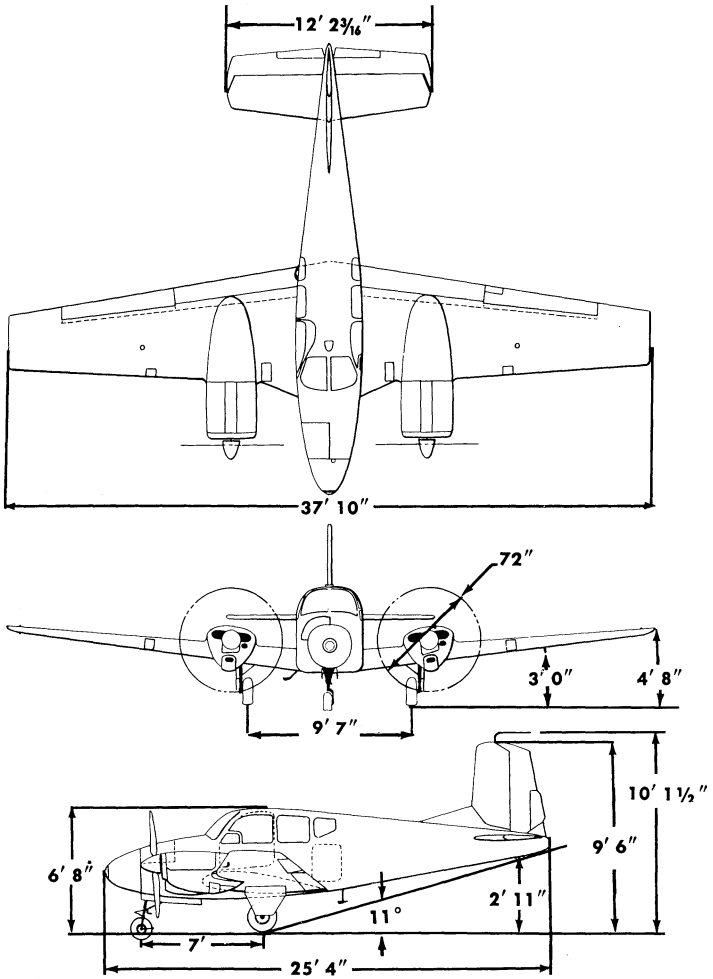

This Is Your Travel Air

THE Model 95 TRAVEL AIR is a four-place, low wing monoplane with a maximum gross weight of 4,000 pounds. The all-metal, semi-monocoque airframe structure is of aluminum, magnesium and alloy steel, riveted and spotwelded for maximum strength. Careful workmanship and inspection make certain that structure strength will withstand flight loads in excess of the CAA requirements for a "Normal" category, under which the Model 95 is licensed.

Power is furnished by two Lycoming O-360-A1A engines, each rated 180 horsepower at 2700 rpm for both take-off and maximum continuous operation. Each engine drives a Hartzell two-blade, constant speed, full feathering propeller.

Under normal gross load configurations the Model 95 has a cruising speed of 200 miles per hour at 75% power (2450 rpm), and a maximum speed of 210 miles per hour (2700 rpm) in level flight.

The TRAVEL AIR has fully-retractable tricycle-type landing gear. When retracted, the wheels and struts are completely enclosed by fairing doors to reduce drag to the minimum.

Space for electronic equipment and the electrical system's 24-volt battery is provided in the upper portion of the nose compartment; in addition, the compartment may be used for baggage within the placarded weight limitations. The aft baggage compartment is accessible both through the door on the right side of the fuselage and from inside the cabin by reaching over the rear seat back.

Coat hangers secured overhead behind the rear seat may be used to hang clothing in the baggage compartment, without folding. Clothing hung here is completely clear of the passenger area, yet readily accessible in flight. The compartment door has a key type lock for security of items stored in the baggage compartment when the aircraft is parked.

The baggage compartment floor is fitted with tiedown lugs for lashing cargo, and pockets on the back of the rear seat may be used to stow small, loose items.

The ventilating system and combustion heater, with windshield defrosters and a blower for heater operation on the ground, provide an adequate supply of both cold and heated air under thermostatic control.

Flight control surfaces are of the conventional three-control type and have controllable trim tabs; all controls and tabs are manually operated from the cockpit and the trim tabs have cockpit position indicators.

CABIN ARRANGEMENT

The conventional side-by-side interior arrangement of the TRAVEL AIR cabin offers all the advantages of executive transport comfort with "safety engineered" appointments. Pilot and passenger fatigue factors have been taken into consideration wherever they are pertinent in designing the airplane. These primary design considerations assure relaxed, comfortable, speedy travel.

All occupants of the aircraft have excellent visibility through the large tinted, ultra-violet-proof windshield and side windows. Both rear windows open for ground ventilation and have positive locks to prevent opening in flight. Release pins permit the windows to be used as emergency exits. Attractive upholstery and "wall to wall" carpeting add distinctive styling and finish to the remainder of the cabin furnishings and complement the basic color scheme of the aircraft. These travel-designed interiors also include cabin loudspeaker, front seat sun shades, shoulder harness, adjustable seats, collapsible armrests, detachable headrests and other comforts of truly "hushed" air travel.

ASSIST STEP

To make entering the Travel Air cabin easier an assist step is located behind and below the trailing edge of the right wing and there is hand grip on the fuselage above and ahead of the step. To reduce drag, the step is retracted and extended with the landing gear.

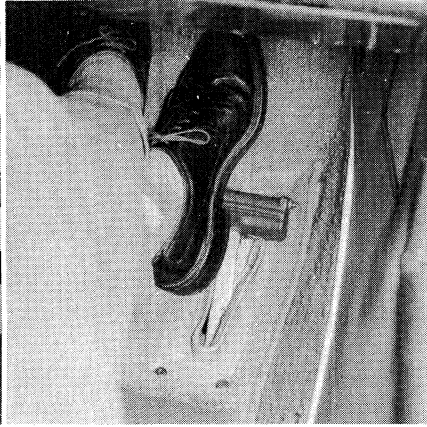
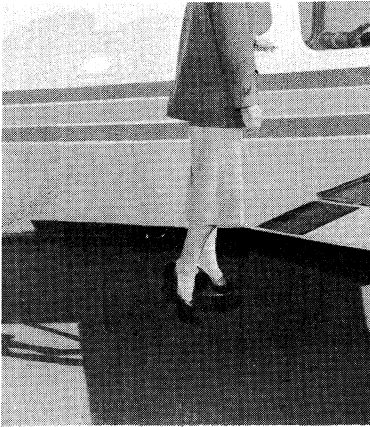

SEAT ADJUSTMENTS

Since people come in different shapes and sizes, the Travel Air's seats may be adjusted to fit the individual comfort requirements of their occupants. Both front seats are adjustable fore-and-aft by pulling up on the small lever just to the right of each seat cushion and pulling or pushing on the seat. The front seat backs are also adjustable to three positions off vertical. Except when the aircraft is to be operated from the right side, the right hand set of rudder pedals may be laid forward against the floorboards, for maximum leg room.

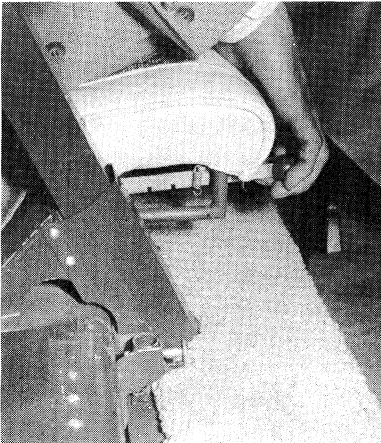

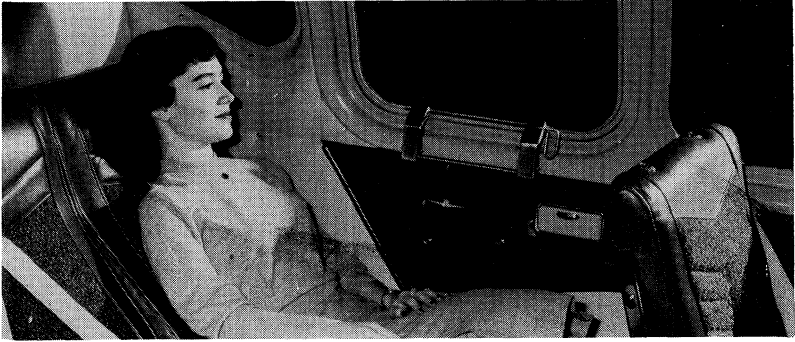

The rear seat back also may be adjusted to three positions off vertical by pulling forward on the seat back to raise it or pulling forward until the catch releases, then pushing back again, to lower it. On aircraft TD-174 and after the rear seat backs may be individually reclined. Levers at the outboard edge of each rear seat control the reclining mechanism.

In addition to the four seats described above, an optional fifth seat is available for installation in the baggage compartment. The seat folds back out of the way when not in use. Optional structure added to the fuselage supports the seat. To provide the necessary room for the fifth passenger, rear seats with shorter backs are installed on which head rests of the type used on the front seats may be installed.

ARMRESTS AND HEADRESTS

Armrests for both front and rear seat passengers are built into the cabin sidewalls and the door; a cup in the door armrest forms a convenient handle for pulling the door closed. A center armrest in the rear seat back may be swung down or folded up into the seat back, and a generously-proportioned armrest between the two

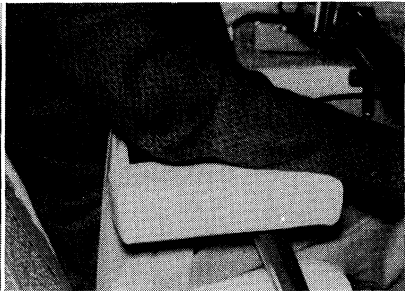

front seats may be raised into position on a pedestal, or lowered flush with the seat cushions. On TD-174 and after, the center arm rest slips out of sockets in the seat frame and may be stowed in the pocket under the seat.

All four passenger seats have sockets for attaching large, pillow style headrests, two of which are provided as standard equipment. On TD-174 and after, when the optional fifth seat is not installed, only the two front seats have sockets for headrests, one of which is provided as standard equipment. The pillows may be used comfortably in connection with the shoulder harness and will lessen fatigue during a long flight or rough air operation.

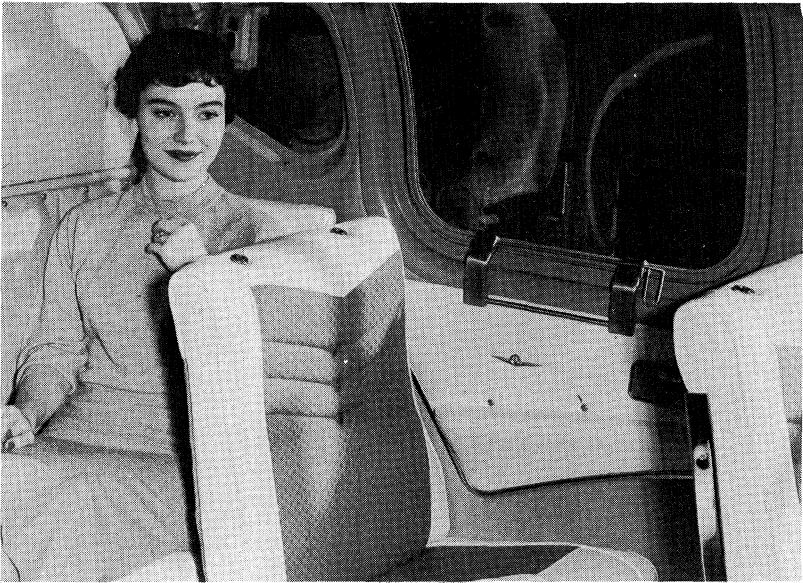

BLANK PAGE

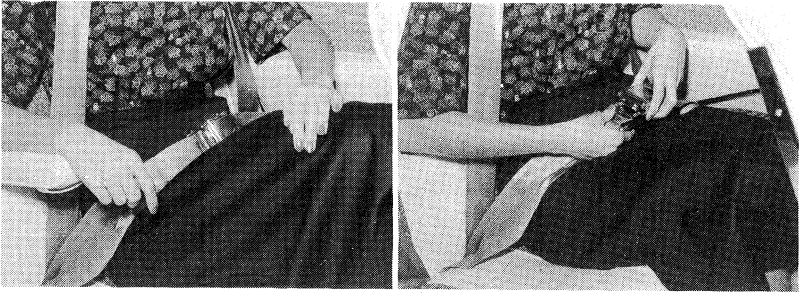

SHOULDER HARNESS AND SAFETY BELTS

The Beech designed high-strength shoulder harness and safety belts on your Travel Air, if properly worn, will keep its occupants snugly in their seats in rough air or under rapid deceleration. Tests show that shoulder harness will protect its wearer in sudden straight ahead decelerations approaching 20 Gs. The harness is mechanically simple and comfortable and wearing it you have sufficient freedom of movement to easily operate all the controls. The nylon strap material, in colors complementing the upholstery, is soil resistant and easily cleaned. The airline-type harness buckles may be fastened or released quickly and are easily adjusted.

ASH TRAYS AND LIGHTERS

For the convenience of passengers who smoke, there is an electric cigarette lighter in the control console. Pull-out ash trays are incorporated in the cabin door and in each side panel for both front and rear seat passengers. To remove an ash tray for emptying, depress the snuffer bar and pull the tray out of its mounting.

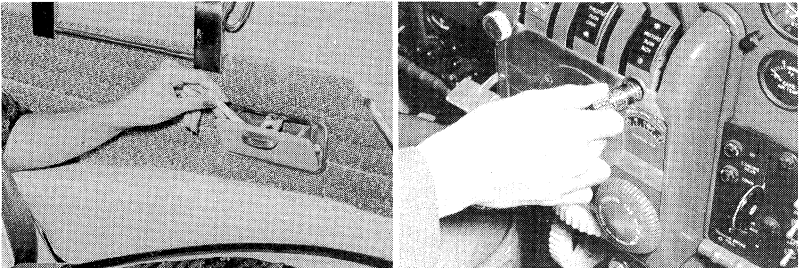

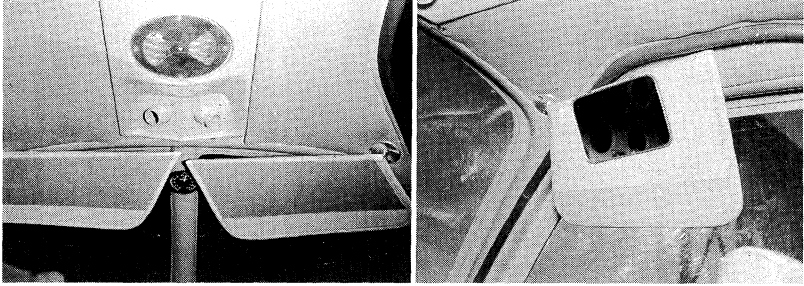

SUN VISORS

Individual front seat sun visors, as standard equipment, may be adjusted to shield either the pilot's or front seat passenger's eyes as desired. For maximum forward and upward visibility, the visors may be laid back completely clear of the windshields.

SPECIAL FEATURES

Among the special new design features and advantages incorporated in the Model 95 are the dynafocal type engine mounting which reduces engine vibration to an absolute minimum. Acoustically engineered and soundproofed, the cabin has the lowest noise level of any light twin in the TRAVEL AIR's class. For control of engine cooling, electrically-operated, gill-type cowl flaps are adjustable at the touch of a switch.

The fuel system uses a cross-feed arrangement which makes available the entire fuel supply of both wings to be used by either engine. This safety feature makes possible continued flight on one engine, if necessary, until the entire fuel supply for the aircraft is exhausted.

Landing gear and wing flap switches are designed to be pulled back out of a detent before they can be repositioned, to help avoid accidental tripping.

The extra-large floating instrument panel, designed for a more flexible instrumentation including several combinations of optional radio navigational equipment, features the SAE type of accepted indicator arrangement and optional individual instrument lighting. As an extra BEECHCRAFT safety feature the airspeed indicator,

calibrated in both miles per hour and knots, is marked with a blue line range for single-engine operation.

The greater wing area and aspect ratio attained with the addition of the new wing tip to the basic wing design increases the over-all take-off, climb and service ceiling performance of the aircraft, especially during single-engine operation.

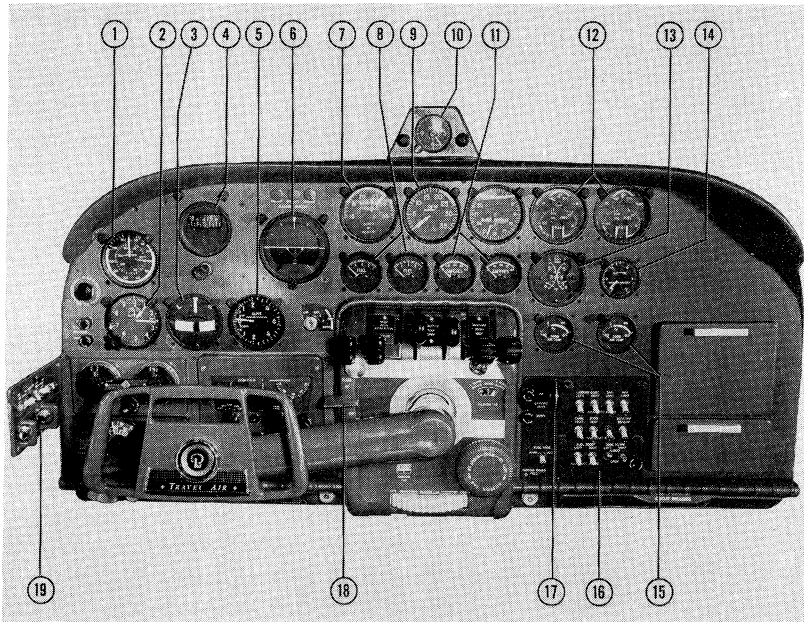

- | | |
|--------------------------------|---|
| 1. Airspeed Indicator | 11. Ammeters |
| 2. Altimeter | 12. Engine Gage Units |
| 3. Turn-and-Bank Indicator | 13. Dual Cylinder Head Temperature Gage |
| 4. Directional Gyro | 14. Suction Gage |
| 5. Rate-of-Climb Indicator | 15. Carburetor Air Temperature Gages |
| 6. Attitude Gyro | 16. Lighting Switch Panel |
| 7. Dual Manifold Pressure Gage | 17. Landing Gear Position Switch |
| 8. Fuel Gages | 18. Flap Position Switch |
| 9. Dual Tachometer | 19. Engine Switch Panel |
| 10. Clock | |

OPTIONAL EQUIPMENT

Due to the variation in aircraft requirements to fit the needs of individual operators, your Travel Air has been designed with the features most needed for average use as standard equipment. Other equipment items are considered as optional equipment. The extra items offered may be installed in your Travel Air at the factory when the aircraft is assembled or by your BEEHCRAFT distributor or dealer. Some items, such as auxiliary wing tanks and super soundproofing, are suitable only for factory installation due to the impracticability of installing them on a completed aircraft.

The following pages describe the majority of optional equipment items available on your Travel Air, either to be specified when ordering the aircraft or installed at a later date by your BEEHCRAFT distributor or dealer.

EVAPORATIVE COOLER

An abundant supply of cooled and filtered fresh air is supplied by the evaporative cooler on the cabin overhead. Without moving parts, the cooler passes air picked up from a scoop in the cabin top over mineral wicks resting in a pan of water. The wicks pick up pollen, and dust from the air and the evaporating moisture reduces its temperature. As with any evaporative cooler, the temperature drop and water consumption depend on the relative humidity of the incoming air; in average summer weather, the water supply will last up to four hours.

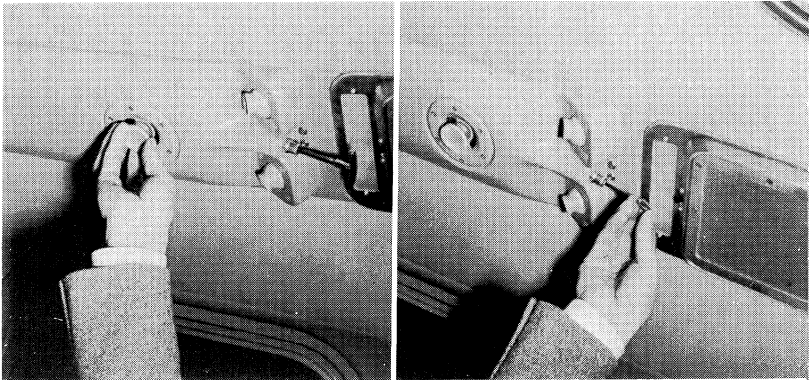

The cooled, washed air is distributed by individually-adjustable outlets in the overhead duct. The hinged airscoop is opened, closed or set in any desired intermediate position to regulate the intake airflow, with a push-pull control placed overhead, just aft of the cabin loudspeaker. Pushing the control in closes the scoop; turning the handle counterclockwise locks it in the desired position. The cooler requires only refilling with demineralized water and a seasonal draining and cleaning to keep it in good working order.

AUXILIARY FUEL CELLS (Factory Installation Only)

For additional fuel capacity, 31-gallon auxiliary cells in the outer wing panels replace the 17-gallon cells; they provide a usable capacity of 112 gallons, while the standard cell arrangement provides 84 gallons of usable fuel.

The large auxiliary cells may be installed only at the time the aircraft is assembled at the factory, due to the extensive rework necessary to install them after the wing skins are riveted in place.

LOOSE TOOLS

In addition to the standard loose tools and accessories, an optional kit with hoisting slings, adapters, and special wrenches for wing and propeller adjustments is available. This equipment is the same type as used by the factory in the assembly of your aircraft and by BEEHCRAFT dealers, distributors, and Certified Service Stations.

PROPELLER ACCUMULATOR

Installed as optional equipment, a 60 cubic-inch air-oil type accumulator unit for each engine assists the propeller unfeathering process.

The accumulator unit is charged with 135 psi of nitrogen or dry compressed air. Oil under pressure obtained from the propeller governor at approximately 300 psi is forced into the accumulator whenever the engine is operated. Through mechanical linkage between the propeller control, propeller governor and accumulator shutoff valve, the accumulator pressure is retained when the propeller control is moved to the full aft or feather position.

When the control for the feathered propeller is moved full forward to the governing range, the governor pilot valve is set to the increase rpm position and simultaneously the accumulator shutoff valve is opened, permitting the oil under pressure in the accumulator to flow through the high rpm passage of the governor and out to the propeller piston, returning the blades to low pitch.

EXTERNAL POWER RECEPTACLE

To extend battery life an external power receptacle may be installed in the upper, outboard side of the left engine nacelle. The power receptacle, which will accept a standard auxiliary power unit's AN plug is connected to the starter relays and when a power unit or battery cart is connected, the electrical system is energized.

External power is of particular value in making radio and electrical equipment checks without starting the engines and, in cold weather, for operating the heater and blower before starting. External power will aid materially in cold-weather starts, also, overcoming the dual disadvantage of high starter loads from cold oil, and lowered battery output.

DUAL CONTROLS

For pilot instruction, familiarization and demonstration purposes, your Travel Air may be equipped with a dual control column having two wheels, instead of the standard throwover control arm. Dual brakes, with master cylinders on the right hand rudder pedals as well as the left hand, plus the deluxe panel with dual flight group provide a complete dual control installation.

TAXI LIGHT AND ROTATING BEACON

Of particular value for night operation are the taxi light and rotating beacon or anti-collision light. The sealed-beam taxi light, which may be used continuously if desired, replaces a chrome plated plug in the center of the nose air intake and is controlled by a toggle switch on the right sub-panel.

For night flying or while under conditions of low visibility, especially in high-density air traffic areas, the anti-collision beacon is almost an essential. It produces two rotating beams of high-intensity red light, 180 degrees apart, which are visible for several miles. The beacon is mounted on the cabin top aft of the baggage compartment and is controlled by a toggle switch on the right sub-panel.

Available as optional equipment on TD-174 and after, a rotating beacon is mounted on the underside of the cabin for additional anti-collision protection.

GENERATORS AND BATTERIES

For operations requiring an electrical system of larger capacity, 25-ampere generators may be substituted for the standard 15-ampere generators. Also available as a replacement for the standard 17-ampere-hour, 24-volt battery are two 24-ampere-hour, 12-volt batteries connected in series to provide the normal 24 volts.

SUPER SOUNDPROOFING (Factory Installation Only)

The acoustics of super-soundproofing achieve a maximum in low cabin noise and vibration levels, a major factor in pilot and passenger comfort. This soundproofing consists of completely encasing the cabin area with an extra heavy fiberglass blanket and an additional coat of asphalt sound-deadener on the inside surface of the fuselage skin. Extra-heavy windshields and a thick foam rubber mat beneath the carpeting further deaden external noises.

INSTRUMENT LIGHTS

Individual eyebrow-type red instrument lights make night flying easier and safer. Individual lighting assures evenly-distributed, illumination without glare or reflections of all the panel instruments. A rheostat switch under the control console controls the lights and adjusts them to the desired intensity. On aircraft TD-174 and after a light mounted on the lower part of the console illuminates the light rheostats and fuel selector panel.

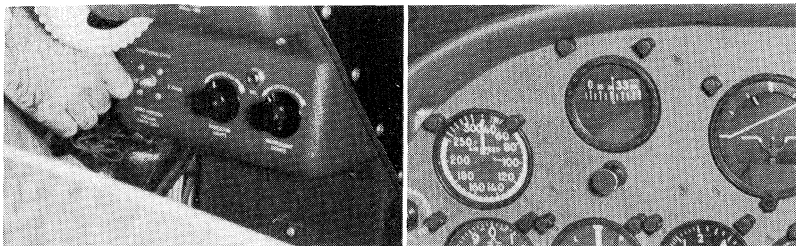

KOLLSMAN DIRECTION INDICATOR

The Kollsman direction indicator is a novel direct-reading magnetic compass which may be mounted on the windshield divider in place of the standard installation. The completely dry, vertical dial corresponding to a compass rose, brings the simplicity of indication to the board compass which has been previously associated only with horizontal reading compasses. Other advantages over the average magnetic instrument include freedom from oscillation, stability in rough air, no operation impairment due to severe temperature changes and the rapidity with which new headings are recorded. Both the period and the overswing are less than half that of the average magnetic indicator.

CARBURETOR AIR TEMPERATURE INDICATORS

For safer and more efficient engine operation, carburetor air temperature indicators may be installed. Individual gages, calibrated in degrees of Fahrenheit, are mounted in the instrument panel and a resistance-type temperature bulb is located in each carburetor air intake plenum. The electrical circuit for the indicators is protected by a 5-ampere circuit breaker. Wiring for the indicators, from the firewalls to the instrument panel, is installed in all aircraft, to simplify later installation of the instruments if desired.

A comparison in flight of the outside air temperature indicator and the carburetor air temperature indicators will show a slight difference, due to heat picked up in the filters and ducts. Carburetor air temperature should not be used to establish a power setting with your horsepower calculator, since it is based on outside air temperature and the temperature rise in the ducts was allowed for in making the calculator.

SINGLE TACHOMETER GAGE

A single tachometer with dual indicator hands and using the original mechanical drive cables may be installed in place of the two standard tachometers, thus leaving an opening in the panel for the installation of other equipment if desired.

Systems and Their Controls

TO develop a good flying technique, you must first have a general working knowledge of the several systems and accessories of your aircraft. Although they are closely interdependent in fact, these systems have been broken down arbitrarily in this section as follows: Flight controls, power plants and controls, fuel system, electrical system and components, vacuum system, heating and ventilation system and pitot and static system. In addition to these systems, this section describes the more important items of optional equipment.

FLIGHT CONTROLS

The primary movable control surfaces of the Travel Air are operated through push-pull rods and conventional closed-circuit cable systems terminating in bell cranks. The pre-formed, extra-flexible steel cables run over phenolic pulleys with sealed ball bearings which ordinarily require no lubrication and insure smooth, free action and long cable life. Standard equipment provides a throw-over type control-wheel arm for elevator and aileron control which may be locked in two positions on either the pilot or copilot side and dual rudder pedals adjustable fore and aft to fit individual pilot requirements. The right hand rudder pedals may be laid flat against the floorboards when not in use. Trim tabs on all flight control surfaces are adjustable from the control console through closed-circuit cable systems which drive jackscrew type actuators. Position indicators for each of the trim tabs are located near their respective controls. The left aileron tab incorporates servo action, in addition to its trimming function. As the aileron deflects from neutral, its tab moves in the opposite direction. This action is independent of the tab's trim function and occurs without disturbing the trim setting.

The single, slot-type wing flaps extend from the fuselage to the aileron on each wing and are electrically operated through a system of flexible shafts and jackscrew actuators driven by a split field, series, reversible electric motor located under the front seat. The flap position lights on the left side of the control console show

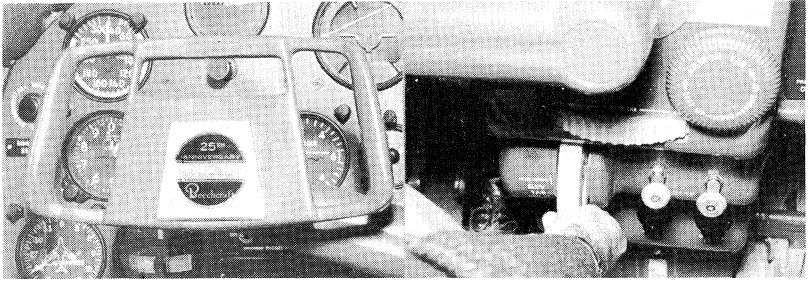

green for the up position and red for the full down (33°) landing position. Intermediate flap positions of 10° and 20° , as marked on the leading edge of the left flap, may be selected by moving the three position control switch, on the left side of the console, to "OFF" when the desired flap setting mark lines up with the wing trailing edge. Limit switches automatically shut off the flap motor when the full up or down position is reached.

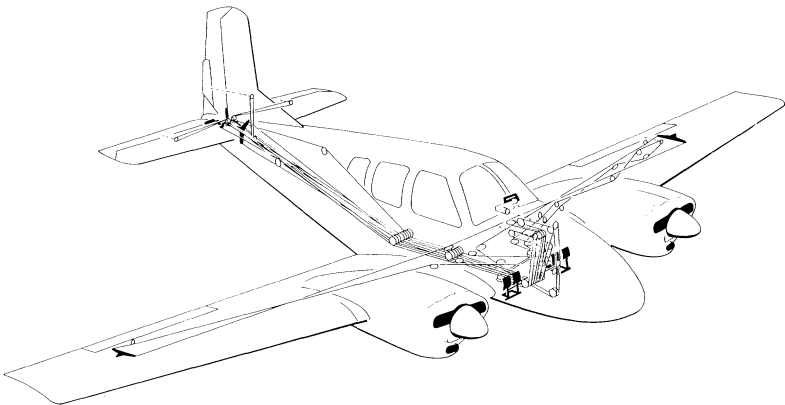

STALL WARNING INDICATOR

As an impending stall is approached a stall warning indicator sounds a warning horn and flashes a red light on the instrument panel while there is still ample time for the pilot to correct his attitude. The stall warning indicator, triggered by a sensing vane on the leading edge of the left wing, is equally effective in all flight attitudes and at all weights and airspeeds. Irregular and intermittent at first, the warning signal will become steady as the aircraft approaches a complete stall.

POWER PLANTS

The Model 95 is powered by two Lycoming O-360-A1A engines rated at 180 horsepower each, at 2700 rpm, for both take-off and maximum continuous operation. They are four-cylinder opposed, air cooled engines with direct propeller drives and have a compression ratio of 8.5:1. They are fitted with a pressure-type cowling; cooling is controlled by opening and closing electrically-operated gill-type flaps on the trailing edge of the cowling. Float-type carburetors are used, with the carburetor air intake through a filtered air scoop at the lower front of each engine. Alternate air is heated to prevent carburetor ice, by heater mufflers around the exhaust stacks; spring-loaded doors in the carburetor intake open automatically if the air scoops or filters are blocked by impact ice or dirt. Full dual ignition systems are used, with an impulse-coupling on the left magneto of each engine for easier starting. The electrical system uses Delco-Remy starters, generators and voltage regulators. Diaphragm fuel pump, vacuum pump and constant-speed propeller governor are standard equipment. Other engine features include sodium-cooled rotator-type valves, chrome piston rings and a nitrided crankshaft.

PROPELLERS

The Hartzell constant-speed, two bladed, hydraulic, full feathering propellers on the Model 95 use pressure from a feathering spring and centrifugal force from the blade shank counter-weights to increase pitch, and engine oil under governor-boosted pressure to decrease pitch.

Above 800 rpm, when the propeller control lever is moved toward the high rpm position (forward) and the propeller is in an under-speed condition, the governor directs oil to a piston on the forward end of the propeller hub. As the piston moves away from the hub,

pitch change linkage connected between the piston and the blades twists the blades toward low pitch. When the propeller control lever is moved toward the low rpm position (aft) and the propeller is in an over-speed condition, oil pressure from the governor to the propeller is relieved and the feathering spring pressure plus centrifugal force from the counter-weights pulls the piston toward the hub and twists the blades toward high pitch.

The propeller is feathered by pulling back on the propeller control past the detent to the limit of travel. Oil from the governor is shut off and a by-pass valve is opened allowing the feathering spring plus the counter-weights to force the oil out of the propeller piston and increase pitch to the feathered position. Automatic, centrifugally-actuated high-pitch stop pins engage the propeller hubs below 800 rpm, to prevent feathering action when the engine is not operating on the ground.

To unfeather, return the propeller control to the governing range (full forward) and start the engine with the starter. On airplanes with the optional unfeathering accumulator, start the engine by moving the propeller control full forward and engaging the starter as the blades begin to unfeather. With the engine operating, governor oil pressure returns the propeller pitch to the cruise setting.

POWER PLANT CONTROLS

The throttle, propeller and mixture control levers, grouped along the upper face of the control console, are within easy reach of the pilot. Their knobs are shaped to military standard configuration so they may be identified by feel.

The levers are connected to their respective units by flexible control cables routed through the leading edge of each wing stub. A controllable friction lock on their support shaft may be tightened

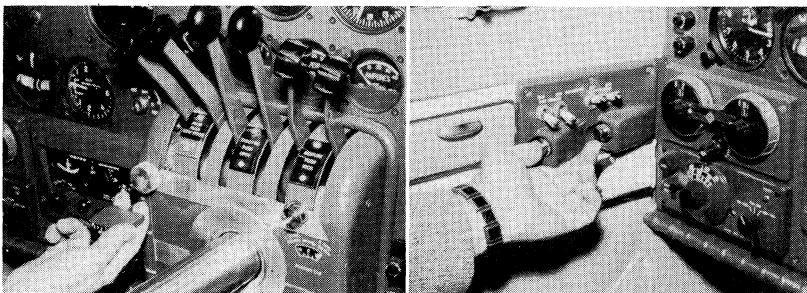

once power settings are established to prevent creeping. Controls for the carburetor heat are push-pull type with center button locks, and are mounted on the lower face of the control console.

The direct-cranking electric starters are relay-controlled and have a single toggle-type starter switch located on the left instrument sub-panel with the individual magneto switches. The three-position (center-OFF) toggle-type switches for the electrically-operated cowl flaps are mounted to the right of the control console on the instrument sub-panel. Intermediate settings for the cowl flaps may be used to maintain the desired cylinder head temperatures.

INSTRUMENT PANEL AND INDICATOR MARKINGS

All the flight and engine instruments are mounted on the floating instrument panel in such a manner that the more important instruments are seen first. Instrument markings have a fluorescent coating for night operation and where practicable the normal operating limits are indicated. The airspeed indicator is marked with a special blue line range for single-engine operation and is calibrated in both miles per hour and knots. The standard panel instrumentation arrangement allots sufficient space for the various combinations of optional instruments and radio-navigational equipment currently available. A map case and glove compartment are conveniently set into the right side of the instrument panel. The map case is of correct size to hold folded aeronautical charts while the glove compartment may be used for the stowage of the surface control lock, pitot head cover and other small articles. The entire instrument panel, sub-panel and console are finished in colors selected to minimize glare and provide maximum legibility.

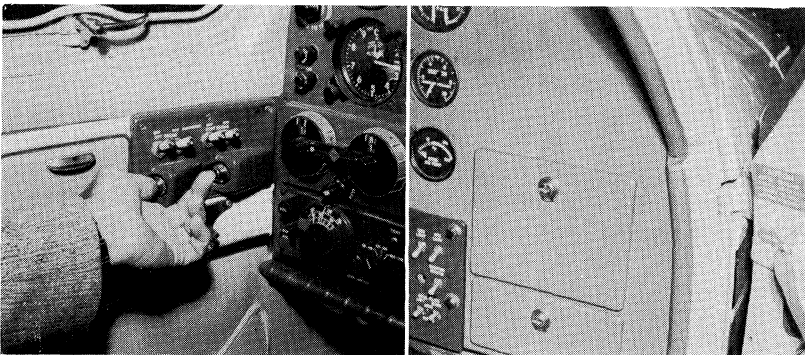

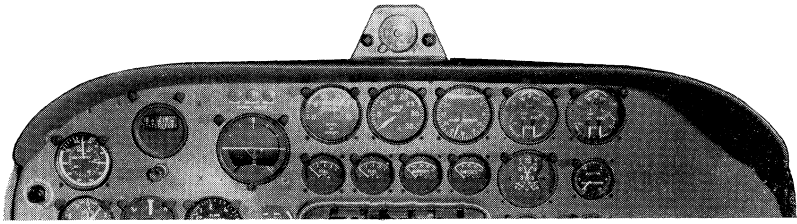

The attractive instrument cowl pad, made of foam rubber encased in dull-finish leather, is shaped to cover the contour above and between the instrument panel and the windshield. This pad, extending aft over the instrument panel in an eyebrow effect, and properly worn shoulder harness give the front seat occupants maximum protection during sudden stop or rapid deceleration.

FLIGHT INSTRUMENTS

Standard flight instrumentation includes attitude and directional gyros, airspeed, altimeter, rate-of-climb, electric turn and bank and a clock. These instruments are appropriately grouped at the left side of the panel for easy reference by the pilot. An outside air temperature thermometer and magnetic compass are mounted in the windshield divider.

ENGINE INSTRUMENTS

The engine instruments, except for the cylinder head temperature, suction and optional carburetor air temperature indicators, are grouped at the top center of the panel. The engine gage units, mounted to the right of the tachometers, indicate fuel and oil pressure and oil temperature for their respective engines. The recording tachometers, driven by flexible shafts from the engine accessory cases automatically total each engine's operating time. The pressure reading for the manifold pressure gage, located to the left of the tachometer installation, is obtained from each engine at the #3 cylinder. The fuel quantity indication is shown by two separate gages, each gage serving both fuel tanks in each wing. The gages are mounted with the ammeters just above the control console.

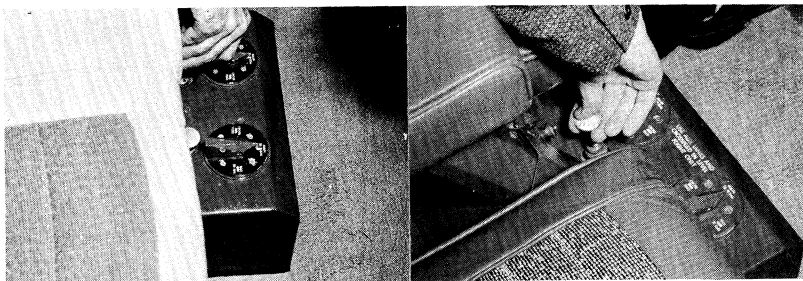

FUEL SYSTEM

The Travel Air's fuel system consists of a separate, identical supply for each engine, interconnected by crossfeed lines for emergency use. During normal operation each engine uses its own fuel pumps to draw fuel from its respective fuel cell arrangement. However, on crossfeed operations the entire fuel supply of any or all cells may be consumed by either engine. A fuel selector valve for each engine controls the cell from which fuel is used.

The standard fuel cell installation uses two 25-gallon main cells in each wing stub and two 17-gallon auxiliary cells in the wing panels outboard of each nacelle. Total capacity for the system, with auxiliary cells, is 84 gallons of usable fuel. With the optional 31-gallon auxiliary wing cells the total capacity is raised to 112 gallons of usable fuel. Fuel cannot transfer from one cell to another during flight.

Fuel quantity is measured by a float-type transmitter unit in each cell, which transmits a signal to the fuel gages on the instrument panel. A two-position selector switch, controlled by the pilot, determines the cell, main or auxiliary, to which each gage is connected. Each cell is filled through its own filler neck with openings in the upper wing surface which are covered by flush-type filler caps.

Individual electric boost pumps for each engine furnish fuel pressure for starting and provide adequate fuel for full-throttle operation should the engine-driven pump fail. Due to the in-line location of the boost pumps, between the cells and the carburetor, fuel may be drawn from any cell within the system by the boost pump for the operating engine. A manually-operated primer for each engine, mounted on the fuel selector panel, supplies fuel taken from the main cell supply line directly to cylinders 1, 2 and 4. The fuel

FUEL SYSTEM

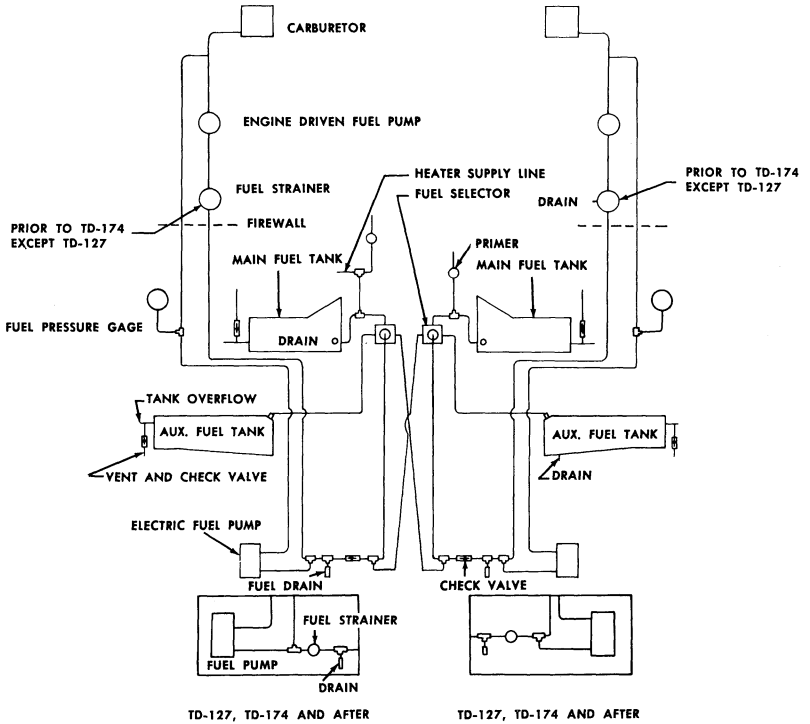

system is drained at eight different locations: four snap-action valves on the underside of the wings drain the cell sumps which are fitted with finger screens; two snap-action valves fitted with extension tubes and located at the system low-spots, extend through the underside of the fuselage and drain the interconnecting lines and selector valves; a quick-drain valve, on the outside of each engine lower inboard cowling, drains the remainder of the system through a fuel strainer and sediment bowl. A check valve is installed in each cell over-flow and vent line to break any tank siphoning action due to temperature changes and fuel expansion or to over-filling.

For single-engine operation, using the crossfeed system, a series of check valves are installed between the crossfeed lines and the carburetors. These check valves prevent the suction of the operating engine's fuel pumps from pulling air into the system through the inoperative engine.

The heater fuel supply is taken from the left main cell. Due to the small amount of fuel burned by the heater, its consumption may be ignored in calculating fuel requirements. The fuel pressure for normal operation, indicated by the engine gage in the instrument panel, is 3 psi desired; 6 psi maximum and .5 psi minimum. The instrument always reads the electric boost pump pressure when it is in use. *Engine-driven fuel pump pressure is indicated only with the boost pump off and the engine operating.*

At least 91/96 octane aviation grade fuel must be used; no lower octane fuel is recommended. *If 91/96 octane fuel is not available, use the next higher grade as an emergency measure until you can obtain the correct grade.*

OIL SYSTEM

The engine oil system is of the full-pressure, wet-sump type and has an 8 quart capacity. For safe engine operation, the absolute minimum amount of oil required in the sump is 2 quarts. Oil operating temperatures are controlled by an automatic thermostat by-pass control incorporated in the engine oil passage of each system. The automatic by-pass control will prevent oil flow through the cooler when operating temperatures are below normal, as during the initial engine warm-up period. It also will bypass if the radiator is blocked. System servicing and draining points are shown on the servicing diagram. The determining factor for choosing the correct

grade of oil is the oil inlet temperature which is observed during flight; inlet temperatures consistently near the maximum allowable would indicate a heavier oil is needed. Only straight petroleum base, aviation grade, non-detergent oil of the lightest weight that will give adequate cooling should be used. Avoid any additive to the basic lubricant.

Moisture that may have condensed and settled in the oil sump may be drained by occasionally removing the oil drain plug and allowing a small amount of oil to escape; ideally, this draining should be done when the engines have been stopped overnight or approximately 12 hours. This procedure should be followed more closely during cold weather or when a series of short flights of less than 30 minutes duration have been made and the engines allowed to cool completely between such flights. For engine operating temperatures to reach and maintain a sufficient heat to evaporate this moisture will take approximately 90 minutes of normal operating time. This moisture content is always present and only under a continuation of abnormal circumstances would it reach harmful proportions.

ELECTRICAL SYSTEM

The TRAVEL AIR's direct-current 24-volt electrical system consists of one 17-ampere-hour, 24-volt battery mounted in the upper portion of the nose section, and two 15-ampere, 24-volt, belt-driven generators connected in parallel. Optional equipment consists of two 24-ampere-hour, 12-volt batteries connected in series to provide 24 volts, and two 25-ampere, 24-volt generators. The generator-to-bus connections are through the voltage regulators and ammeters. Each generator's output is automatically controlled by its voltage regulator and the system paralleling relay which adjusts the generator output so both are equal.

The ammeters in the Travel Air, although of the conventional charge-discharge type, are connected only to the generator output leads and function as loadmeters. With the system working properly, the ammeters will give a positive indication, increasing or decreasing directly with the load applied. Since the generator load also includes battery charging, battery condition may be estimated from the ammeter reading when the battery is momentarily switched off. Normally, the ammeters should show a negative reading only for a moment before the reverse-current relay opens, when an engine slows below generator cut-in speed. Each generator is controlled by

ELECTRICAL POWER DISTRIBUTION

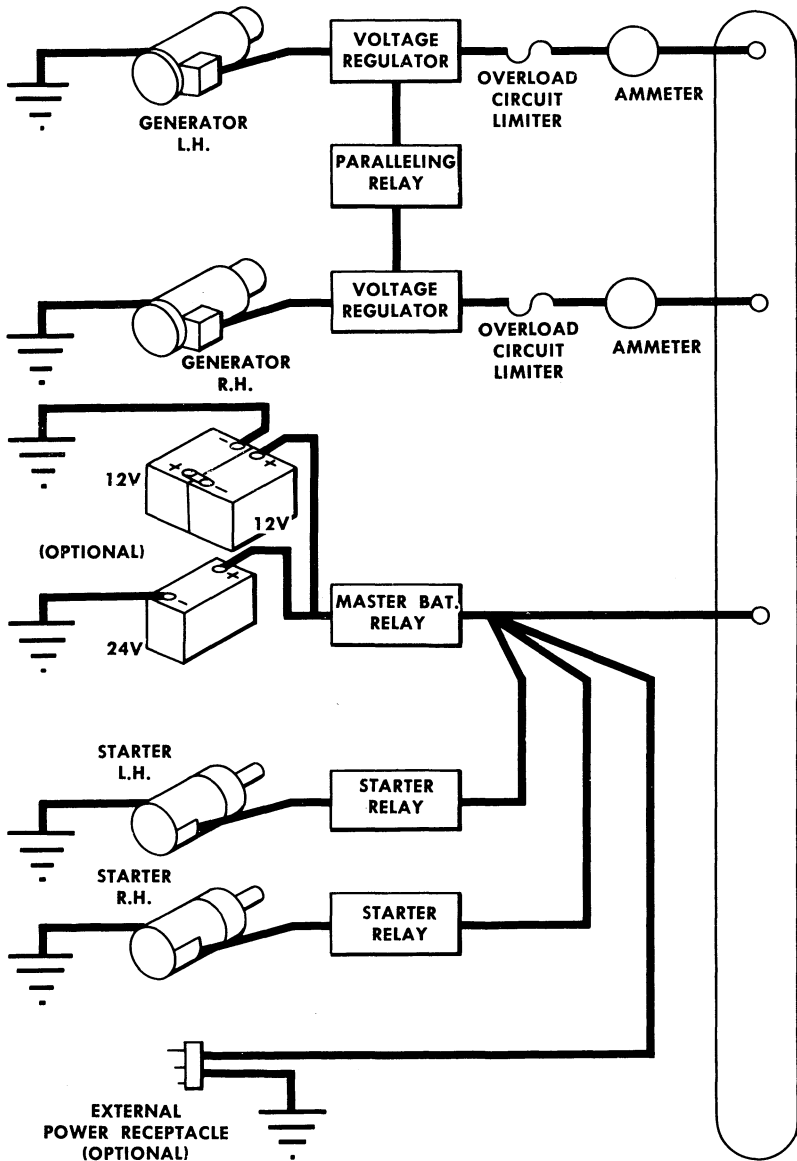

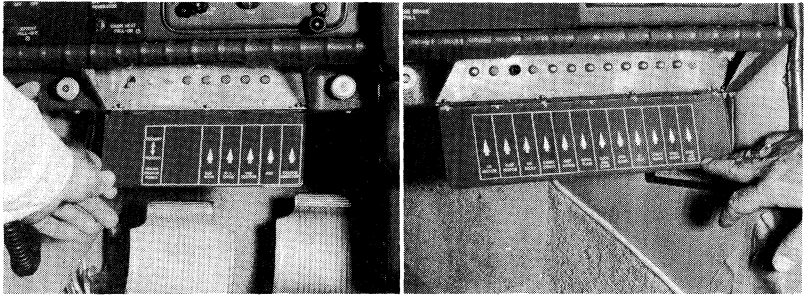

a separate toggle switch on the left instrument sub-panel which opens the generator field circuit when in the "OFF" position. The battery is connected to the main bus system through a master battery relay which is actuated by a master switch on the left instrument sub-panel. On aircraft TD-174 and after a single master switch replaces the separate generator and battery toggle switches. Most of the primary circuits in the aircraft are protected by circuit breakers and are fed through the main bus system, using the aircraft structure as a common ground return. Individual circuit breakers, located along the bottom of the right instrument sub-panel, are placarded with their particular circuit functions and are either the push-to-reset, push-pull or toggle type. Extra space is provided for circuit breakers to protect additional equipment which may be installed later.

The automotive-type starters are relay-controlled which minimizes the length of heavy cable required to carry the high amperage of the starter circuit. A drive unit actuated by centrifugal force from the operating starter motor engages and rotates the external ring-gear at the front of the engine crankcase. When the starter motor is de-energized the drive disengages from the ring gear pinion.

An optional external power receptacle on the left engine nacelle will accept a standard auxiliary power unit's AN plug for ground checks and starting. External power should be used particularly in cold weather when the starting load is greatest and the batteries output is reduced.

RADIO EQUIPMENT

The combinations of optional radio packages available include VHF communications and navigation equipment, marker beacon, ADF and standard broadcast reception in addition to low, medium and high-frequency transmitters and receivers. Since selection of

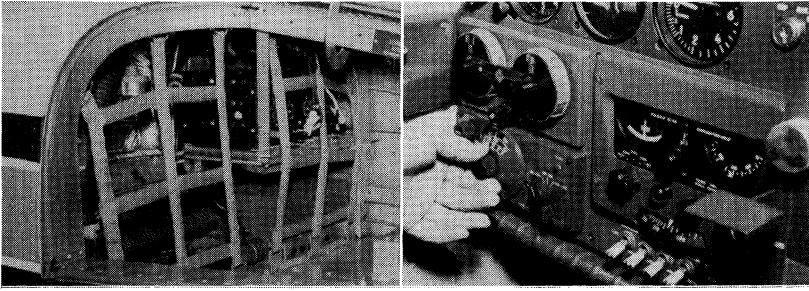

the radio equipment is determined by the needs and preferences of individual operators, detailed discussion of radio equipment has been omitted from this handbook.

All radio equipment is installed in the upper portion of the nose compartment and controlled from the instrument panel. The glass fiber nose section is suitable for ILS and flush-type omni antennas. The completely enclosed glass fiber tail cone may be used to house an ADF loop.

LIGHTING

Cabin and instrument illumination are provided by a lighting system in the cabin overhead panel. The cabin light is controlled by an "ON-OFF" switch beside the light and a rheostat switch beneath the control console adjusts the intensity of the instrument lights.

Sealed-beam landing lights in the leading edge of each outboard wing panel are shielded by clear plastic lenses with a specially-designed shaded area to produce maximum effectiveness. Either light is operated independently by separate switches; operation

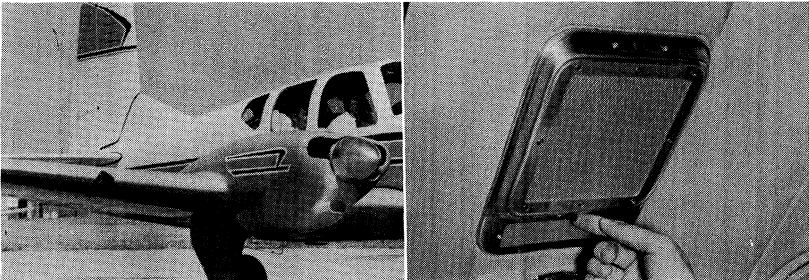

during ground maneuvering or prolonged operation in the air should be avoided. Conventional position lights on the wing tips and tail cone are operated through a flasher unit, designed to give steady lights if a malfunction occurs, and are controlled by a two position switch on the right sub-panel.

Lighting for the trim tab and mechanical landing gear position indicators is controlled by a rheostat switch slightly below the control console.

LANDING GEAR, BRAKES AND STEERING

The TRAVEL AIR's extra-strong, electrically-operated landing gear incorporates the advantages obtainable only with tricycle type gear. The ease of ground operation is assisted by the increased visibility, more positive directional control for parking or operation under high surface wind conditions; decreased stopping distance and longer brake and tire life; these are but a few of the advantages.

The gear is operated through push-pull tubes by a reversible electric motor and actuator gear box under the front seat. The motor is controlled by a two-position landing gear switch located on the

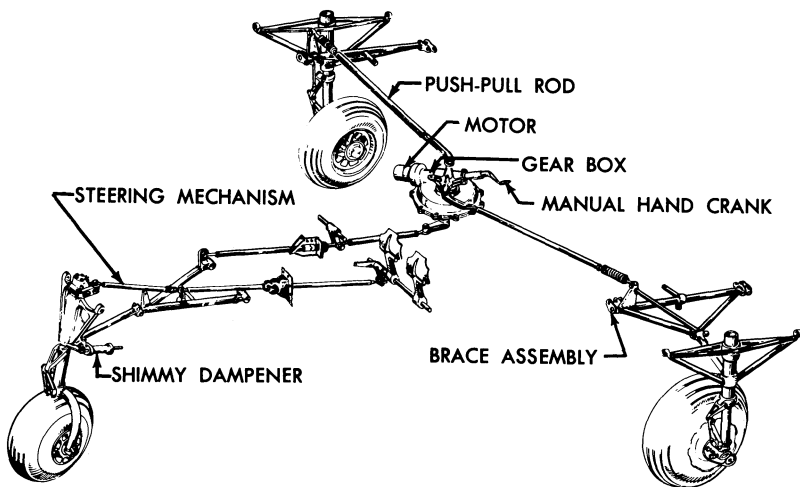

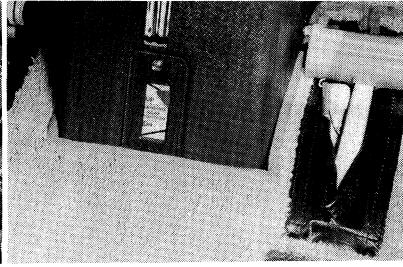
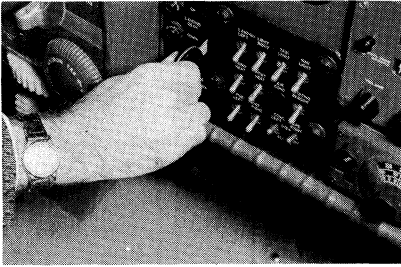

instrument panel. Limit switches and a dynamic braking system automatically stop the retract mechanism when the gear reaches its full up or full down position.

With the landing gear in the up position, the wheels are completely enclosed by fairing doors which are operated mechanically by the retraction and extension of the gear. After the gear is lowered, the main gear inboard fairing doors automatically close, producing extra lift and reduced drag for take-off and landing. Individual up-locks actuated by the retraction system lock the main gear positively in the up position. No down locks are necessary since the over-center pivot of the linkage forms a geometric positive lock when the gear is fully extended. The linkage is also spring loaded to the over-center position.

The landing gear position lights, located beside the landing gear switch, indicate the position of the gear, either up or down; coming on only when the gear reaches its fully extended or retracted position. In addition a mechanical indicator beneath the control console shows the position of the gear at all times.

To prevent accidental gear retraction on the ground a safety switch, on the left main strut, breaks the control circuit whenever the strut is compressed by the weight of the airplane and completes it, so the gear may be retracted, when the strut extends. **NEVER RELY ON THE SAFETY SWITCH TO KEEP THE GEAR DOWN WHILE TAXIING OR ON TAKE-OFF OR LANDING ROLL. ALWAYS CHECK THE POSITION OF THE SWITCH HANDLE.**

When either, or both throttles are retarded below an engine setting sufficient to sustain flight, with the gear retracted, a warning horn will sound an intermittent note. During single engine operation

the horn may be silenced by advancing the throttle of the inoperative engine enough to actuate the warning horn's throttle switch.

The steerable nose wheel, connected to the rudder pedals by a spring loaded linkage, is designed to absorb shocks and automatically caster to the correct alignment upon touch-down, when operating under cross-wind conditions. The retraction of the gear relieves the rudder pedals of their nose steering load and centers the wheel, by a roller and slot arrangement, to insure proper retraction into the wheel-well. A hydraulic dampener on the nose wheel strut compensates for the inherent shimmy tendency of a pivoted nose wheel.

The landing gear wheels are carried by heat-treated tubular steel trusses and use Beech air-oil type shock struts. Since the shock struts are filled with both compressed air and hydraulic fluid their correct inflation should be checked prior to each flight. Even brief taxiing with a deflated strut can cause severe damage.

For manual EMERGENCY operation of the landing gear (lowering only) a hand-crank is located behind the front seat. The crank, when engaged, drives the normal gear actuation system.

The main landing gear wheels are equipped with Goodyear single-disc, self-adjusting hydraulic brakes actuated by individual master cylinders connected to the rudder pedals and operated as toe brakes. The hydraulic brake fluid reservoir is accessible from the forward baggage compartment and should be checked occasionally for specified fluid level. The parking brake is set by a push-pull control with a center-button lock and is located just to the right of and slightly below the control console. Setting the control does not pressurize the brake system, but simply closes a valve in the lines so that pressure built up by pumping the toe pedals is retained and the brakes remain set. Pushing the control in opens the valve and releases the brakes.

VACUUM SYSTEM

Suction for the vacuum-operated gyroscopic flight instruments is supplied by two engine-driven vacuum pumps, interconnected to form a single system. For single-engine operation an automatic check valve for the inoperative engine closes thus forming a complete vacuum system sustained by the engine in use. Either vacuum

VACUUM SYSTEM

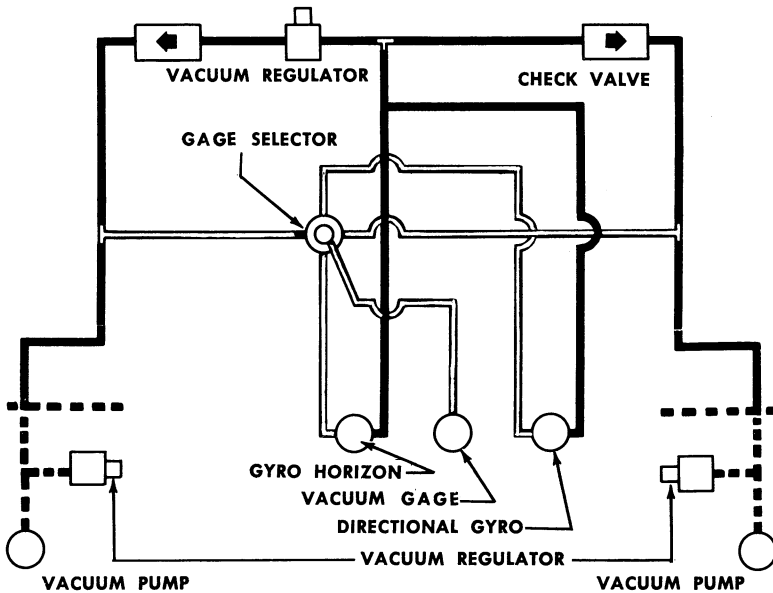

pump has sufficient capacity to maintain the complete aircraft gyro instrumentation.

A vacuum gage selector valve, on the lower control pedestal, permits a check of the vacuum at four points in the system. The valve has four positions: directional gyro, gyro horizon, left pump and right pump. The suction in inches of mercury at any of the points selected is indicated on the instrument panel suction gage. During normal operation the valve should be positioned in either "Directional Gyro" or "Gyro Horizon." Air entering the system is taken in through the using instruments themselves. To eliminate dust and grit, which might injure the instruments, each of the instrument air intakes is fitted with a filter. Sluggish or erratic operation of one or more of the vacuum driven instruments, with a normal suction gage reading, indicates that clogged filter is reducing the volume of intake air to less than the instruments require. Suction in the system is controlled by adjustable, spring-loaded valves. One in the instrument line just ahead of the instrument panel acts as a system regulation valve and one in each engines nacelle acts as a relief valve. All three valves are set to bleed air into the system as required to maintain the correct suction supply.

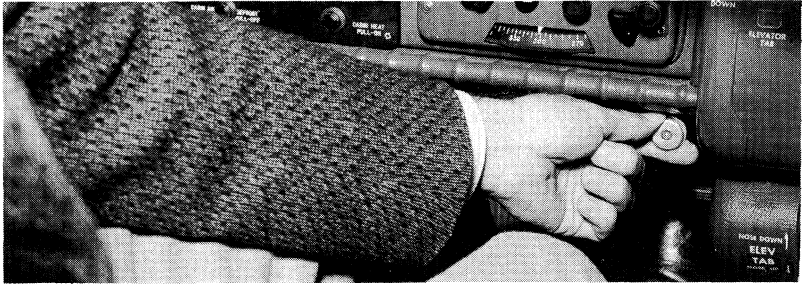

HEATING AND VENTILATING SYSTEM

The fresh air heating and ventilation system in the nose of the Travel Air provides an ample supply of heated or cold air to the cabin both in flight and on the ground. Manually-operated cockpit controls regulate the heater and the air supply for individual preferences. The system consists of a Janitrol 35,000 BTU combustion heater, a ventilation air blower, fuel pump, fuel-filter, shut-off valves and temperature-limiting thermostats. An iris-type air valve controlled from the cabin admits ram air taken in around the nose taxi light into the blower and the combustion heater plenum. All ventilation air passes through the heater before it is distributed to the cabin and windshield defroster outlets.

For flight operation, ram pressure alone forces fresh air through the system; on the ground, when ram pressure would be insufficient, a ventilation blower maintains air flow through the system for either hot or cold air. The blower is controlled by a switch connected to the landing gear actuation linkage in the fuselage center section, so that the blower operates when the landing gear is down, the "Cabin Heat" switch "ON" and the "Cabin Air" control in. The blower is shut off automatically when the gear is retracted, and may be shut off manually through the instrument panel switches or by pulling the "Cabin Air" valve control out approximately half way, partially closing the iris valve in the intake and opening a blower switch in the control linkage. This switch also turns off the heater since with the iris valve only slightly open the intake air will be insufficient for proper heater functioning.

To obtain more cabin heat during flight in low outside air temperatures, pull the "Cabin Air" valve control out as far as possible without shutting off the heater. This reduces the volume of air passing through the heater thus enabling the heater to raise the temperature of the air to a comfortable level.

Heater operation is controlled by a ductstat in the distribution plenum, which acts as a cycling thermostat to maintain within close tolerances the temperature selected with the mechanical thermostat control, by starting and stopping the heater. The "Cabin Temperature" control, on the left sub-panel, adjusts the opening

HEATING AND VENTILATION

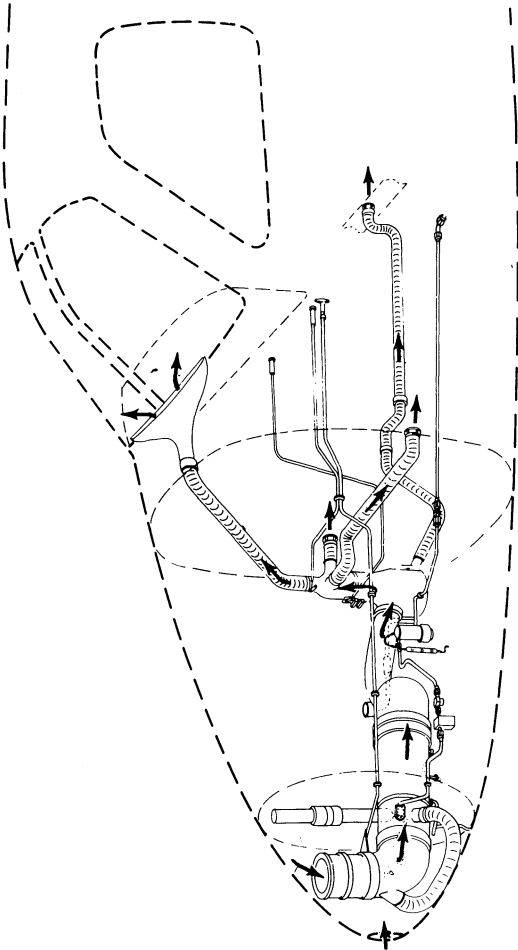

temperature of the ductstat. When less heat is required, the opening temperature is lowered, and when more heat is required, the opening temperature is raised. The ductstat upper limit is set at 180°F, to prevent uncomfortably-hot air from entering the cabin. The windshield defroster duct serves a dual purpose; in addition to its normal function, cabin ventilation may be more evenly distributed by using it as a variable cold air outlet.

A normally-open thermostat in the heater discharge plenum acts as a safety device, to render the heater system completely inoperative if a malfunction should occur which would result in dangerously-high temperatures. This thermostat is set to close at 300°F, grounding a circuit through a fuse in the heater power supply. Grounding the circuit will blow the fuse, disconnecting all power to the heater circuits. It does not affect the blower circuit, however. The fuse is located on the upper right-hand segment of the bulkhead behind the instrument panel, in a place chosen deliberately for inaccessibility in flight. Since any condition causing this fuse to blow will be hazardous, its location is intended to prevent replacement before the malfunction has been investigated and corrected. Such an arrangement is required by Civil Aeronautics Board regulations, for combustion-type heaters.

Fuel for the heater is drawn from the left main wing tank, by a separate, electric fuel pump. The heater fuel line is equipped with a strainer. A spring-loaded solenoid valve, which closes whenever the heater is off, prevents any seepage of fuel from the line into the inoperative heater.

If a heater malfunction should occur resulting in the overheat fuse blowing, the system should be thoroughly checked and the malfunction corrected before the heater is operated again.

The heater ignition unit, mounted in the nose cap, uses a vibrator to provide interrupted current for its high-voltage coil. The unit is equipped with two sets of points; a toggle type switch, located beneath the left sub-panel, will place the alternate set in service. When the alternate points are used, the points should be replaced as soon as practicable.

PITOT AND STATIC PRESSURE SYSTEMS

Impact air pressure and atmospheric air pressure for the airspeed indicator, altimeter and vertical speed indicator are supplied by

PITOT AND STATIC AIR SYSTEM

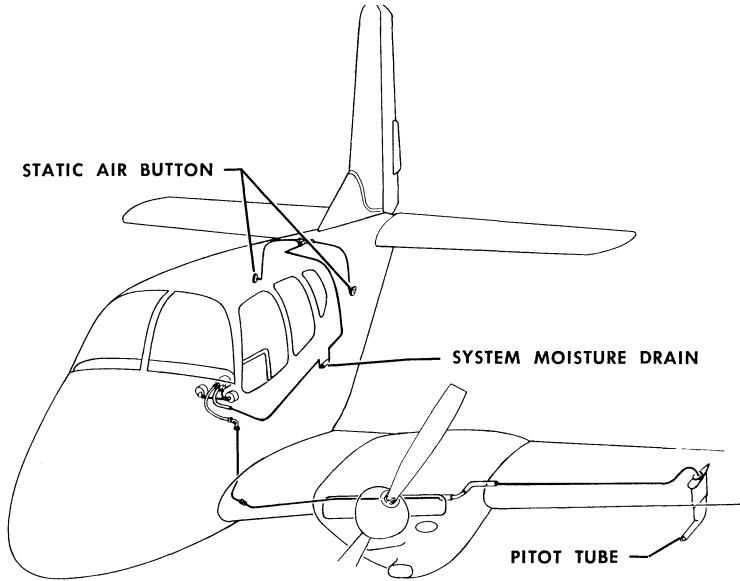

the pitot and static air systems. Since the accuracy of these instruments depends on accurate pickup of the two pressures, the systems have been developed carefully and tested in flight with highly-accurate special equipment.

The static air system picks up atmospheric pressure from buttons on each side of the fuselage just aft of the last cabin bulkhead, where they are least affected in flight by impact pressure and turbulence. Lines from the buttons are connected to a single line which runs forward to the instrument panel, where it is connected to the airspeed, altimeter and vertical speed instruments. A short length of rubber tubing in the static pressure line, accessible through an opening in the left side of the baggage compartment, may be disconnected to drain moisture from the system.

Operated by the differential between impact air pressure and atmospheric air pressure, the airspeed indicator is connected to both the static system and the pitot system. Impact pressure is picked up by the pitot head, mounted on a mast under the left wing, and conducted inboard to the instrument panel. Since the pitot head is subject to impact ice accumulations, it is equipped with an electric heating element, controlled by a switch on the right sub-panel.

Proper operation of the pitot and static systems may be vital to your safety, and their proper care merits your personal attention. Both the pitot and static port openings must be kept free of foreign matter. Always install the pitot cover whenever the aircraft is parked, and make a check of the openings a part of every preflight inspection. Sluggish or obviously-low indications from all three instruments will result from even a partial restriction in the static system, while similar response from the airspeed indicator only may indicate a restriction in the pitot system. Limit ground operation of the pitot heater to brief periods for functional checks.



Flying the Travel Air

TO the pilot with many hours of multi-engine experience, much of the material in this section, and in the section on emergencies, will be familiar. He can scan whole pages, make mental notes of a few points and go on, for the Travel Air is quite a normal twin-engine airplane. This section is aimed primarily at the pilot, however experienced, to whom steering with the throttles may be a novelty; if to the experienced multi-engine pilot this section seems over-large, his indulgence is asked.

The specific information of this section as to operational limitations, necessary precautions and procedures, have been determined through engineering computations and flight testing of the aircraft. The general handling technique presented is based on the recommendations and data compiled by Beech Aircraft Corporation pilots who have test flown and demonstrated the aircraft, and may be followed with confidence in forming your own procedures. The tables and diagrams give a working basis for figuring the aircraft's performance under many combinations of the variable factors connected with flying. However except for the limitations and precautions mentioned, both the procedures and the graphs are intended primarily as guides and are no substitute for good judgment.

In general the aircraft is characterized by excellent stability, handling ease and high maneuverability; the controls are effective throughout the speed range from stall to maximum dive velocity. You will find the Travel Air has no unconventional traits or peculiarities to master; it behaves exactly as an airplane should.

EXTERIOR INSPECTION

To a pilot, the general airworthiness of his aircraft is both a legal obligation and a direct responsibility to his passengers and himself. Personal attention to the preflight procedures is the mark of a safe pilot and will repay you not only in safety but in lower maintenance costs as well.

In addition to the checks listed below, the “walk-around” portion of your preflight inspection should include checking the rig and freedom of control surfaces, visually checking the condition of the windshield and side windows, antenna rigging and dents and scratches in the skin or other minor damage which should be noted and evaluated.

The following items require specific checking during the “walk around” phase of the preflight inspection:

1. Cabin for desired arrangement; battery and magneto switches “OFF.” Adjust all trim tab controls to indicate a “O” reading. Remove and stow the control lock.

CAUTION

Under circumstances where propeller blast or windy conditions are likely to be encountered when opening the cabin door, retain the door forcibly by hand and position it against the open stop, thus preventing the possibility of damage to the door or its hinges.

2. Static pressure buttons for foreign material; trim tabs streamlined with the control surfaces.

3. All access doors and inspection openings covered and their fastenings secure.

4. Wing tips and position lights for damage; remove pitot cover and tie-down lines.

5. Fuel level in all cells: check visually then replace and secure the filler caps.

6. Drain the fuel sediment bowls and strainers (2 places); the fuel selector valves (2 places) and the fuel cell sumps (4 places).

7. Engine oil level, open cowling and read from the graduated dip-stick in the oil filler cap; replace and tighten the filler caps.

8. Inside each nacelle for evidence of oil, fuel or exhaust leakage; secure cowling.

9. Propeller blades for freedom from nicks and scratches.

10. Tires and shock struts for specified inflation and cleanliness. Landing gear safety switch for security and obvious damage. Main gear tire pressure 36 psi; nose gear tire pressure 28 psi. All shock struts extended 2 inches (under normal fuel and oil load only).

11. Baggage compartments for cargo security; doors closed and latched.

12. Aircraft loading within the specified weight and balance limitations.

BEFORE STARTING ENGINES

1. Lock the cabin door and windows. Fasten your safety belt and be sure your passengers do the same; use shoulder harness as desired.

2. Set parking brake; adjust seat and rudder pedals.

3. Check all controls for full travel and freedom of movement.

4. Set the altimeter and clock; uncage the gyro instruments.

5. Check circuit breaker panel.

6. Landing gear switch DOWN. Mechanical indicator under the control pedestal full DOWN.

7. Carburetor heat controls full forward (cold).

8. Fuel selector valves on the main fuel tanks.

9. Radio switches "OFF."

10. Battery and generator master switches "ON." If an auxiliary power unit is to be used, leave the master switches "OFF."

11. Check the fuel level indication for all cells.

12. Check the landing gear and flap position lights, both green, and test the stall warning light, red.

13. Cowl flaps "OPEN." (On aircraft TD-174 and after, check the cowl flap position light, amber.)

14. Position the propeller controls full forward (low pitch, high rpm).

15. Position the throttles about $\frac{1}{4}$ inch open.

16. Set trim tabs — 0 to 3 points nose up, depending on your loading.

STARTING

Look over the area around the aircraft to be sure of sufficient taxi clearance with respect to other aircraft, buildings or other structures. Make sure your propeller blast is in the clear before running up the engines.

The use of prime for engine starting is largely a matter of individual preference and the operational temperatures concerned, both atmospheric and mechanical. With atmospheric temperatures above 30°F priming normally is unnecessary while below 30°F it is usually beneficial.

1. Left magneto switch “ON” for engine to be started.

2. Cold engine starting: mixture controls full forward (rich mixture). Apply 2 or 3 full strokes with the hand primer on the engine to be started.

Hot engine starting: mixture controls full aft (idle-cut-off). Advance mixture control after the starter is actually cranking the engine; do not prime.

3. Fuel boost pump “ON” only for engine to be started. Check fuel pressure indication.

4. Propeller clear.

5. Actuate the starter switch. Limit each cranking period to a 10 or 12 second operation. A 5 minute cooling and rest interval, between cranking periods, will extend starter life.

NOTE

Should the engine stop firing completely due to an excessively rich mixture or flooded condition, move the mixture control full aft (idle-cut-off), turn “OFF” the magneto switch and move the throttle control full forward. Engage the starter and turn the engine through approximately ten revolutions. Following the check list procedure, attempt a restart. *Do not pump the throttle; to do so will only increase the possibility of flooding.*

SMOKE AND FLAME IDENTIFICATION

POSSIBLE INSTRUMENT INDICATION	DANGER	CAUSE AND REMEDY	SMOKE AND FLAME PATTERN
High CHT and CAT fluctuating MP, rpm.	Loss of power, engine failure.	CAUSE: Detonation, afterfire or backfire from lean mixture and/or carburetor failure. REMEDY: Enrich mixture, reduce power and temperature. Watch engine instruments.	Puffs of black smoke from exhaust. Rough engine.
Drop in oil pressure.	Slight possibility of fire.	CAUSE: Slight oil leak. REMEDY: Shut down and check. Be alert for fire.	Thin wisps of bluish-grey smoke from cowl flaps and exhaust areas.
High CHT; fluctuating MP, rpm, and low oil pressure.	Engine failure and fire.	CAUSE: Cylinder head or exhaust stack failure. REMEDY: Shut down and check. Be alert for fire.	Variable grey smoke and possible light flame from cowl flaps and exhaust areas.
Sudden drop in MP and rpm with high CHT.	Uncontrolled fire.	CAUSE: Initial induction fire from burning fuel. REMEDY: Increase rpm, try to draw fire thru engine.	Heavy black smoke from exhaust.
Variable oil pressure. High CAT.	Uncontrolled fire.	CAUSE: Oil leak and oil fire. REMEDY: Shut down, fight fire.	Black smoke from accessory section.
Variable fuel pressure, high CAT.	Uncontrolled fire.	CAUSE: Fuel leak and fire. REMEDY: Shut down, fight fire.	Black smoke and orange flame from accessory section.
Drop in MP, RPM, low CHT.	Slight possibility of fire.	CAUSE: excessively-rich mixture, carburetor failure. REMEDY: Lean mixture, shut down and check carburetor.	Black smoke, perhaps orange flame from exhaust.

6. After the engine is running evenly, turn on the right magneto switch and open the throttle to an indicated engine speed of 800 rpm; check the engine gage for oil pressure indication. If no pressure is shown within 30 seconds, stop the engine.

7. When engine temperatures have begun to rise, advance the throttle to an indicated engine speed of approximately 1300 rpm for warm-up.

8. Switch the fuel boost pump "OFF" and check the engine driven fuel pump pressure and operation.

9. Start the remaining engine using the same procedure.

10. Disconnect external power, if used, then turn on battery switch.

EXTERNAL POWER

Before connecting an auxiliary power unit, turn "OFF" the battery and generator switches and all other electrically-operated equipment. If the auxiliary power unit does not have a standard AN type plug, check the polarity of the unit and connect its positive lead to the center post and the negative lead to the front post of the aircraft's external power receptacle. The aircraft, being negative-ground, requires a negative-ground auxiliary power unit; reversing the polarity of the unit can produce a battery fire or serious damage to other electrical equipment. *Make sure of polarity before the unit is connected.*

TAXIING

NEVER TAXI WITH A FLAT SHOCK STRUT

Ground operation under its own power is quite easy in the Travel Air, with its excellent visibility, short turning radius and maneuverability. Normally, warm-up rpm will supply sufficient power for ground operations except when taxiing over rough areas or under extremely windy conditions.

To taxi, simply release the parking brake control and allow the aircraft to start rolling forward, check the brakes by applying them several times lightly, thus assuring that the brakes are functioning properly and are ready for use. Unless sudden stoppage is probable, do not "ride" the brakes. Govern your taxi speed with throttle coordination. Most turns may be made with the steerable nose

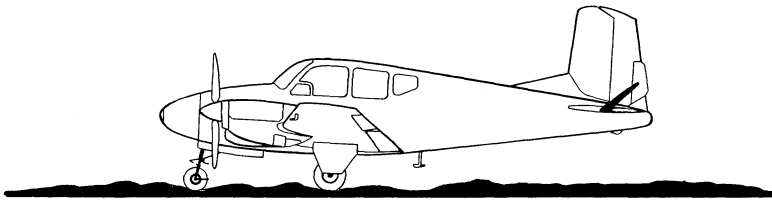
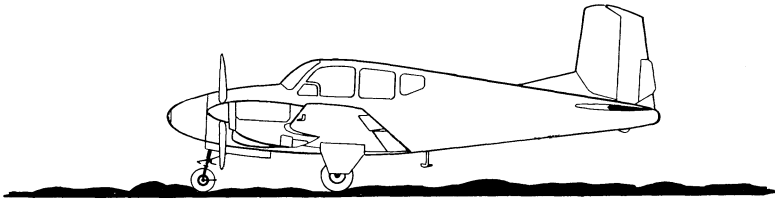

wheel and the throttles. Tight turns may be accomplished by applying a combination of inside brake and outside power.

When taxiing over rough surfaces use minimum power settings and allow the aircraft to coast over obstructions. Do not apply brakes suddenly unless absolutely necessary. Hold the control column full back to reduce weight and relieve loads on the nose gear assembly. Although the nose wheel is unusually strong, always be conscious of its location and the fact that the airplane is pushing it along the ground.

WARM-UP AND PREFLIGHT CHECKS

After you have reached the designated or pre-determined point on the airport for engine run-up, which should be at least 100 feet from the active runway, head the aircraft into the wind, straighten the nose wheel and set the parking brake. If necessary allow the engines to complete their warm-up at 1300 rpm. Limit ground running as near as possible to 4 minutes in cold weather and 2 minutes at temperatures above 70°F.

To attain maximum engine cooling, the rpm settings given are those to be used with the propellers in full low pitch (high rpm)

and when the aircraft is warmed-up and checked on a clean hard-surfaced area. Reduce the rpm accordingly for other types of surfaces to prevent damage to the propellers and underside of the fuselage from small stones, sand etc. picked up and thrown by the propellers.

When normal engine operating temperatures are reached, set either throttle at 2200 rpm and complete the following checks:

1. Visually check for both engines – oil temperature, 140°F minimum for run-up. Oil pressure – 85 psi maximum, 60 psi minimum and 25 psi idling. Fuel pressure – 5.0 psi maximum, 0.5 psi minimum and 3.0 psi desired.

2. Re-check the fuel gages for correct reading with the electrical system now in operation.

3. Check the ammeter gages for correct generator output. Generator cut-in speed should be approximately 1250 engine rpm.

4. Mixture controls full forward (rich mixture).

5. Pull the carburetor heat control out. Correct operation will be indicated by a drop in manifold pressure and engine rpm. If equipped with carburetor mixture temperature indicators, a heat rise will be noted.

6. Turn the vacuum selector valve to the engine being checked. The suction gage should indicate about 5.4 inches Hg. Position the valve in either “Directional Gyro” or “Gyro Horizon” after the check.

7. Pull the propeller control lever aft to the high pitch detent and reposition it full forward again after the propeller has changed to high pitch (low rpm) and the engine speed has stabilized. Exercise the propeller through this cycle 2 or 3 times to assure correct governing action.

NOTE

When exercising the propellers within their governing range, do not move the control lever aft past the detent. To do so will allow the propeller to change rapidly to the full feathered position.

8. Advance the throttle to full open, 2550 to 2600 static rpm and switch "OFF" each magneto separately for approximately 3 seconds. Maximum drop should not exceed 75 rpm.

9. Reduce the engine speed to idle rpm and switch "OFF" both magnetos just long enough to determine if the engine stops firing. To avoid spark plug fouling, do not idle the engines at low speeds for prolonged periods.

10. Adjust engine speed to approximately 1300 rpm and repeat steps 5 through 10 for the other engine.

11. Set the gyro instruments.

12. Check pitot heat, by observing the ammeters when the switch is turned "ON," then "OFF."

13. With the propeller controls full forward, in the low pitch (high rpm) position, open both throttles simultaneously with a smooth, steady motion and observe if power is developed equally in both engines. Retard the throttles to approximately 1300 rpm. On an average day, with full throttle, the static rpm should be approximately 2600. Bear in mind, however, that atmospheric conditions affect both the manifold pressure and rpm obtainable and that on a cold day with high barometric pressure it is possible to exceed the manifold pressure limit.

14. Adjust the friction lock on the control console tight enough to prevent the engine controls from creeping.

15. Turn the fuel boost pumps "ON" and check the indicated pressure.

16. Visually check the control console from top to bottom and the instrument panel from right to left. Special attention should be given to fuel and oil pressures, oil temperature and cylinder head temperature.

NOTE

Since the propellers are feathered by a spring which exerts a constant pressure, and will do so whenever the governor boosted oil pressure to the propeller hub is relieved, it is

not necessary to check the feathering cycle with each pre-flight inspection. The heavy loads imposed on the engine offset the advantages of the check.

NORMAL TAKE-OFF

When you are ready for the take-off run and have moved into position on the active runway, release the brakes and open both throttles smoothly and evenly, maintaining positive directional control with the rudder pedals. Do not exceed 28.5 inches Hg. or 2700 rpm.

CAUTION

If you are taking-off or landing behind a large multi-engine or jet aircraft, allow sufficient spacing so that the air turbulence in the wake of the other airplane will dissipate and settle before you encounter it. This turbulence may remain for several minutes, depending upon the wind direction and velocity, and is severe enough to cause even large aircraft to become uncontrollable.

As an airspeed of approximately 70 *mph* is attained, apply a gentle but steady back pressure, sufficient to bring the wings to a slightly positive angle of attack. As lift-off speed is reached, approximately 85 *mph*, normal back pressure should cause the aircraft to fly off the ground.

Once you have broken ground, hold some forward pressure to avoid excessive angle of climb until normal climb speed, 105 *mph*, is attained. Retract the landing gear as soon as you are firmly airborne with no danger of settling back to the runway. If 10 degrees or more of wing flap are used, delay your retraction until a safe airspeed is attained. Turn the fuel boost pumps "OFF" individually and check the fuel pressure indication.

Remember, on a hot day, a longer run will be required for take-off than under average temperatures. The same rule is true as field

elevation increases since lift is attained only through actual density altitude. Though your airspeed indications will be the same, almost twice the runway length will be required to attain lift-off airspeed at an airport elevation of 6000 feet than under the same conditions at sea level and your ground speed will be appreciably higher also. Watch the airspeed needle, rather than the runway markers, and be sure you have sufficient *airspeed* before applying back pressure for the lift-off. Other conditions to be considered at all field elevations and during every take-off, are runway surface condition, runway gradient, aircraft gross weight and surface winds. A good take-off depends on the correct allowances for all these factors. Do not forget them.

Section IV on Cruise Control discusses the effect of temperature and barometric pressure on your aircraft's performance. These factors influence all performance, all the time, and you should understand them thoroughly.

SOFT OR ROUGH FIELD AND MINIMUM RUN TAKE-OFF

To get the aircraft airborne in the shortest forward distance traveled, under less than ideal surface conditions, use 20 degrees of wing flap and adjust the elevator trim from "O" to 3 points "nose up," depending on the loading; apply full power and release the brakes. The control wheel should be held well back during the beginning of the take-off run, to establish the maximum possible angle of attack. As the take-off run progresses and landing gear drag decreases, the angle of attack should be gradually reduced for better acceleration to flying speed. Lift-off should occur at approximately 70 *mph*; however, this speed will vary with your loading and atmospheric conditions. As you become fully airborne, relax back pressure to permit the aircraft to accelerate, and retract the landing gear. Retract the wing flaps as normal climb speed is attained.

OBSTACLE TAKE-OFF

Where an obstacle must be cleared on take-off or under conditions where you must attain a maximum of altitude in a minimum of forward distance, use 20 degrees of wing flap and set the elevator trim, between "O" and 3 points "nose up," as required; apply full power available and release the brakes. Hold the wings in a near

NORMAL TAKE-OFF

0 WIND

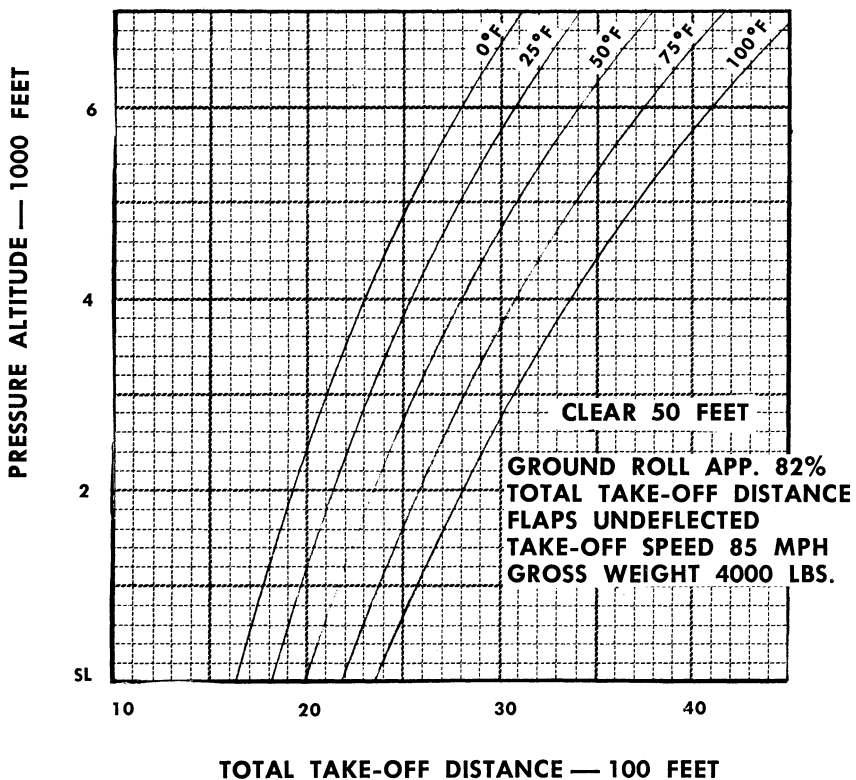

NORMAL TAKE-OFF

10 MPH WIND

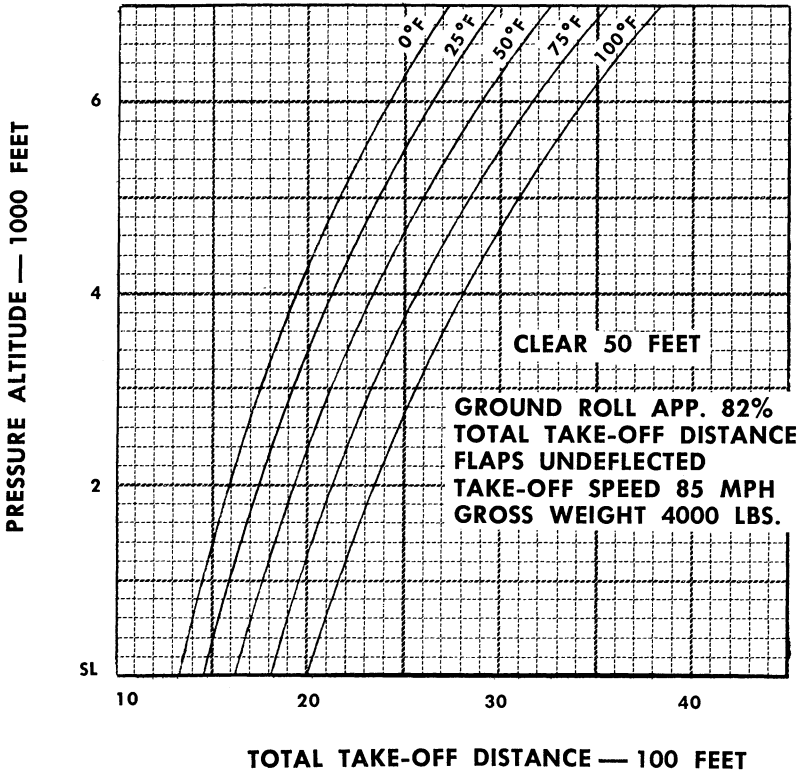

NORMAL TAKE-OFF

20 MPH WIND

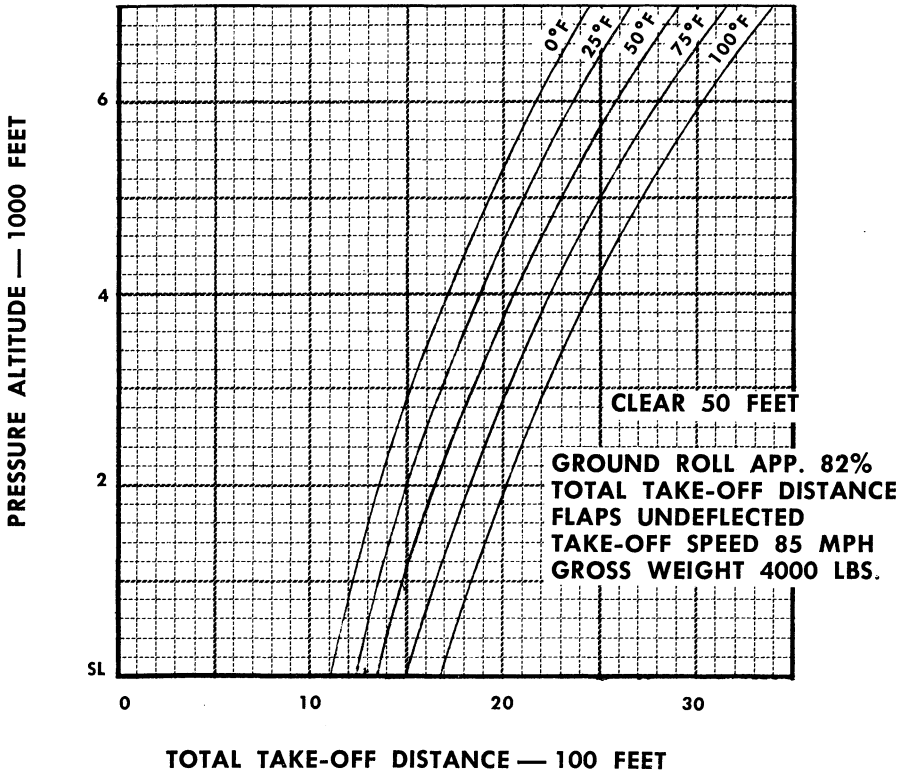

NORMAL TAKE-OFF

30 MPH WIND

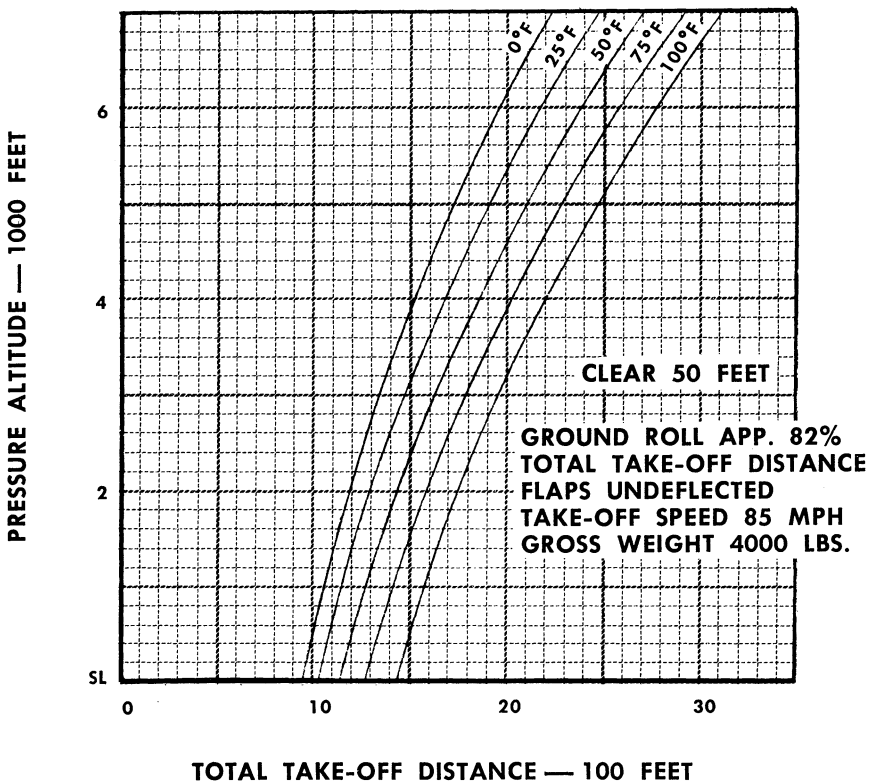

MINIMUM RUN TAKE-OFF

NO WIND

TAKE-OFF DISTANCE VS ALTITUDE
GROSS WEIGHT 4000 LBS.

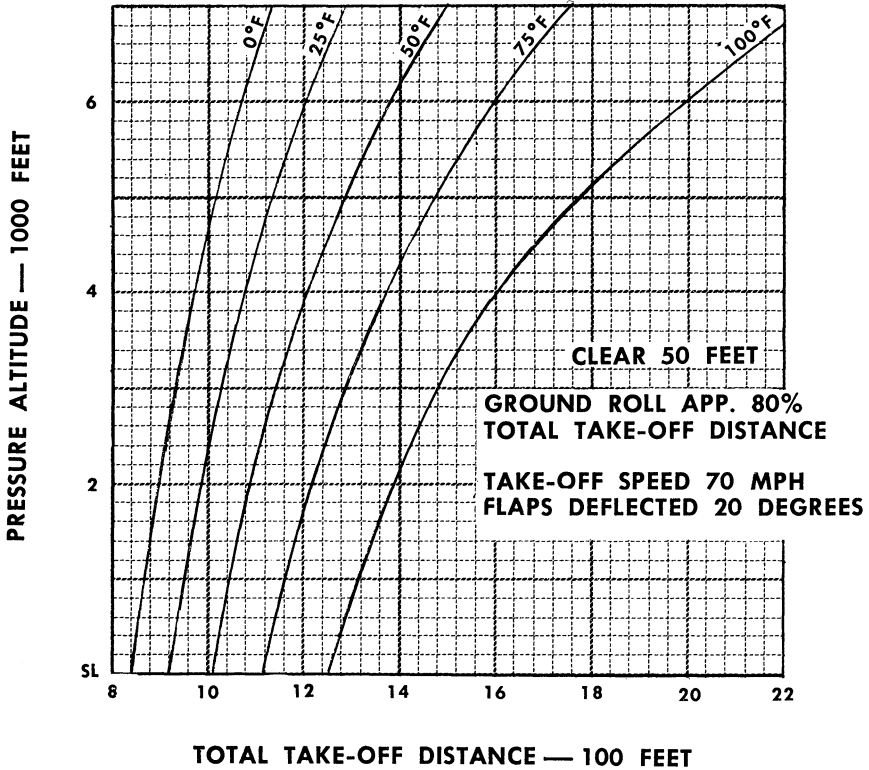

MINIMUM RUN TAKE-OFF

10 MPH WIND

TAKE-OFF DISTANCE VS ALTITUDE
GROSS WEIGHT — 4000 LBS.

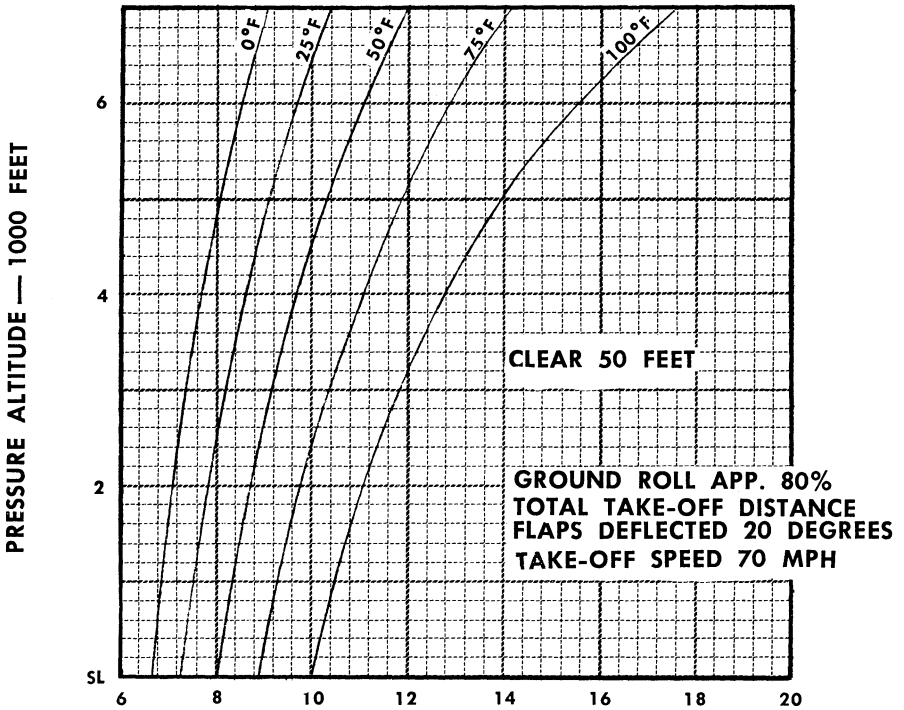

TOTAL TAKE-OFF DISTANCE — 100 FEET

MINIMUM RUN TAKE-OFF

20 MPH WIND

TAKE-OFF DISTANCE VS ALTITUDE
GROSS WEIGHT 4000 LBS.

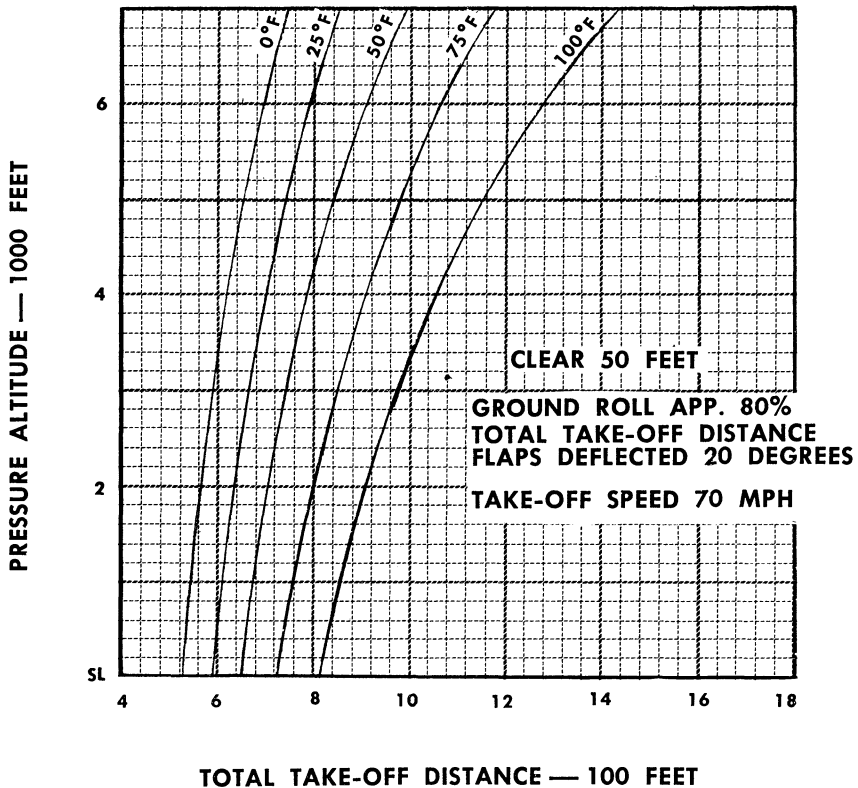

MINIMUM RUN TAKE-OFF

30 MPH WIND

TAKE-OFF DISTANCE VS ALTITUDE
GROSS WEIGHT 4000 LBS.

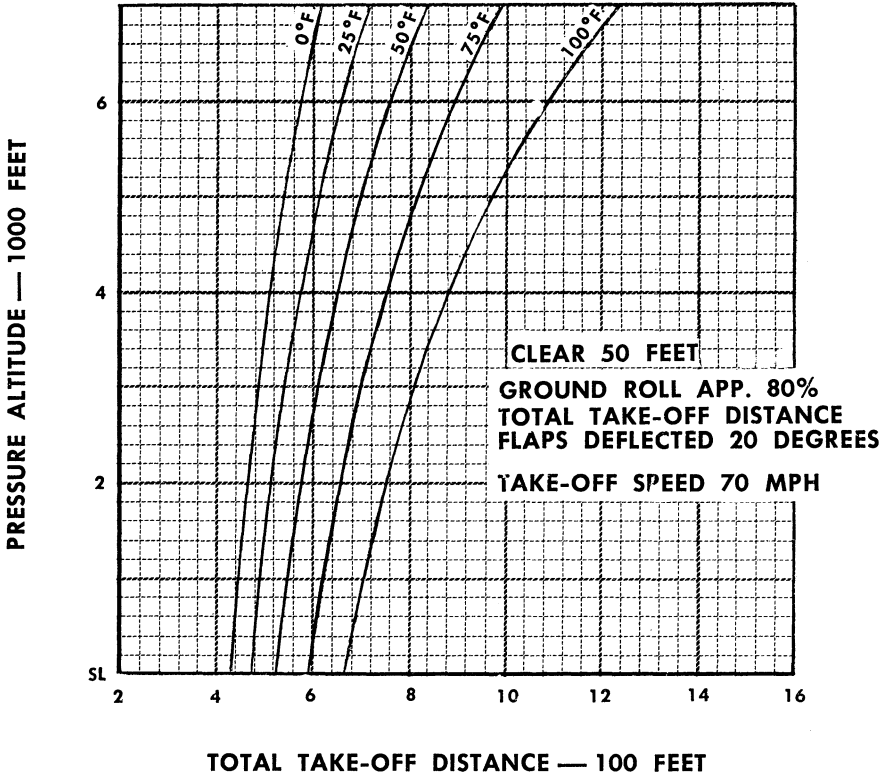

level flight attitude during the take-off run, until lift-off speed of approximately 70 *mph* is attained, then smoothly and positively apply back pressure, to assume a nose-high, climb angle. After you have positively cleared the ground, retract the landing gear and maintain the nose-high attitude to obtain the maximum angle of climb until the obstacle is cleared. The best *angle* of climb speed, 95 *mph*, will allow you to climb clear of an obstruction in the shortest distance. After you are in the clear, level off and accelerate to normal climb speed and retract the wing flaps.

CROSSWIND TAKE-OFF

Under normal crosswind conditions, take-off procedures differ from the standard into-the-wind technique only during the latter part of the take-off run and during the actual lift-off. Wing flap and trim tab settings that correspond to a normal take-off operation may be used. As power is applied and flying speed is gained, apply forward pressure on the control wheel to keep the nose gear solidly on the ground for maintaining positive directional control. At the same time counter the crosswind action by holding the wings level with the ailerons. When you have attained lift-off speed, approximately 75 *mph*, pull the aircraft off with a definite back pressure on the control wheel, and relax aileron and rudder pressures to allow the aircraft to establish its own crab angle. This will effect a straight track in reference to your ground roll. Lower the nose as you accelerate to the normal climb speed, and retract the landing gear.

CLIMB

With the Travel Air's exceptional climb performance, you have a choice of two satisfactory methods for reaching a cruising altitude.

A climb at best rate-of-climb speed will get you to altitude quickly. It may be mandatory in IFR conditions; or save some fuel over-all if you have a good tailwind aloft. However, you will have reduced forward visibility due to the high climb angle and the ascent will be less comfortable for your passengers. On the other hand, a cruising climb will give you good visibility, it will be more comfortable and with good fuel management it may save both time and fuel, since you can make shallow climbs at near cruise speeds with only moderate power increases. Your choice of method will depend on the weather, the length of the flight, your load and your own preference.

TWO-ENGINE CLIMB PERFORMANCE

TIAS VS ALTITUDE
GROSS WEIGHT
4000 LBS.

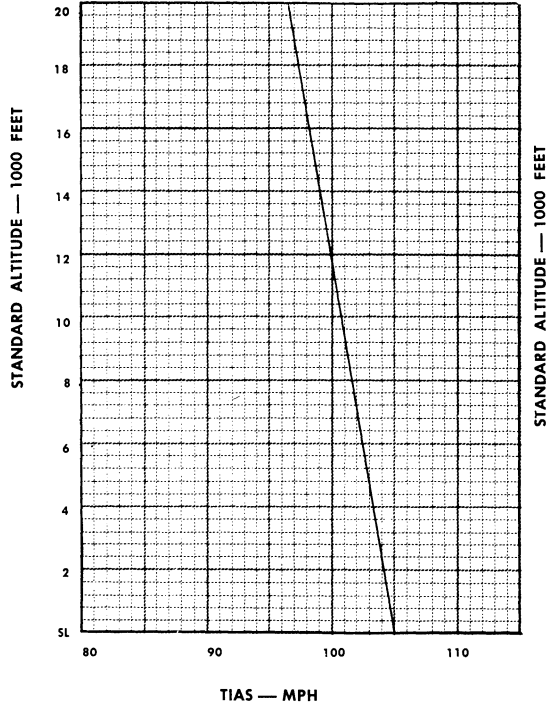

RATE OF CLIMB VS ALTITUDE

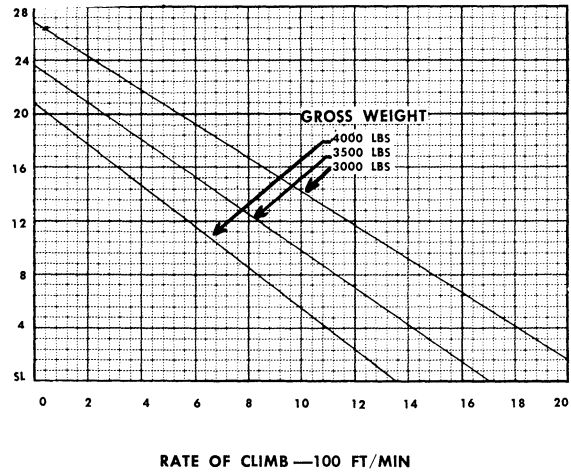

For the best rate-of-climb, which will give the greatest gain in altitude per minute, use normal rated power of 2700 rpm and full throttle. Hold the best rate-of-climb speed shown on the climb graph for your altitude; note that the speed reduces approximately 1 mph for each 2000 feet you climb.

For a cruising climb, which is generally recommended, use a power setting between 2450 and 2500 rpm and up to 25 inches of manifold pressure. Set your climb to hold an IAS of 130 to 140 mph. Cowl flaps should be closed at or above 130 mph.

CAUTION

Never use full throttle with an engine speed of less than 2450 rpm, below 5000 feet. With an engine rpm of 2350 or less, do not exceed 65% power.

To obtain optimum fuel economy, you may lean during a climb, at reduced power — 2450 rpm or less — beginning at an altitude of 3500 feet. Do not lean, however, under 5000 feet at power settings in excess of 2450 rpm.

To commence leaning, after you have the desired rpm and manifold pressure settings, pull the mixture controls aft in small increments. While observing the cylinder head temperature indicators closely, continue to lean out until peak temperature has been reached. If a sudden temperature rise occurs during leaning out, or if maximum permissible temperature is reached, return the mixture controls to full rich immediately. *Keep the cylinder head temperatures under 450°F at all times.* When applying carburetor heat, adjust power setting and mixture as necessary.

CAUTION

If during the course of your flight, dense haze or clouds are encountered, the rotating anti-collision beacon should be turned "OFF." The reflection of these lights, particularly at night, can produce optical illusions and severe vertigo.

CRUISE

Level-off when you have reached your intended cruising altitude and maintain climb power, until you have accelerated to your intended cruising IAS. This procedure will allow your airspeed,

TIME TO CLIMB

VS
ALTITUDE
GROSS WEIGHT
4000 LBS.

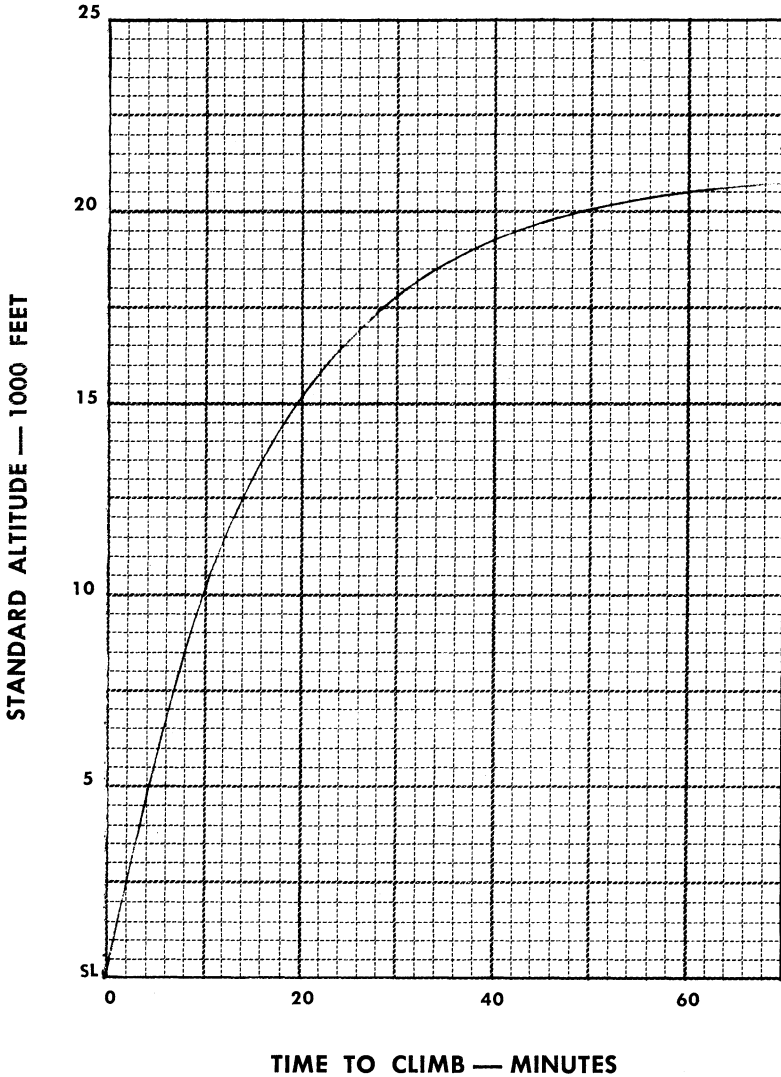

engine temperatures and power settings to become stabilized in a shorter period of time.

As cruising speed approaches, reduce your power settings. There is no "best" cruise power setting for all flights. Your choice of power settings will depend on load, temperature, altitude and perhaps most important, the purpose of your flight. You should, however, weigh these factors in advance and decide on your approximate power settings during your flight planning prior to take-off. The graphs and discussion in the section on Cruise Control were placed there to aid you in doing so.

Since the efficiency of the aircraft in cruise — the airspeed obtainable with a given horsepower — is affected considerably by its trim, your trimming procedure becomes an important task. Using the turn-and-bank indicator, adjust the rudder trim as required to zero the ball, then adjust the elevator and aileron trim. This sequence is of particular importance in twin-engine aircraft. By stabilizing your directional control first, you eliminate any slipping or skidding and the excess drag that results. For maximum efficiency, merely trimming "hands-off" is not sufficient. Use the turn-and-bank, rate-of-climb, airspeed and gyro instruments as trimming aids. They supply a far more reliable reading of what the aircraft is actually doing than may otherwise be detected.

Synchronization of the propellers is accomplished by setting one propeller at the desired engine speed, and then adjusting the other propeller control. An intermittent "beat" will be slightly audible if the propellers are not exactly synchronized.

Final mixture adjustments may be accomplished using the same leaning procedure as applied during the climb-out. Remember, do not permit the cylinder head temperatures to exceed 500°F.

The fuel selector valves may be positioned to use fuel as desired while normal cruising operations are continued. However, since your take-offs, climbs and landings must be made using the main fuel cells only, a sufficient reserve for a safe landing at your destination must be maintained. Providing the length of a flight will allow enough fuel for this reserve, the main cells only may be used for the operation. Otherwise, you should switch to the auxiliary fuel cells when you have established your cruising altitude. Also, remember that the auxiliary fuel and crossfeed systems may

be used in level flight only. When one selector valve is positioned on crossfeed, both engines are using fuel from the cell indicated by the remaining selector valve. If both selector valves are on crossfeed, the fuel supply for both engines is cut-off. Normal operation allows fuel to be consumed from the cells as indicated by the fuel selector valves.

Also, during cruise operation, be alert for signs of carburetor icing which is most likely to be encountered during operations where you are traveling through one kind of weather and into another. The conditions under which you are most likely to find carburetor ice are diagnosed and discussed more completely under "cold and all weather operation" in the following pages of this section.

DESCENT EN ROUTE

For a cruising descent en route, with the intention of continued cruising operation at another altitude, relieve only enough power to obtain the desired let-down IAS and rate of descent. Power should be sufficient to keep the engines warm and the cylinders clear. Richen the mixture slightly to avoid lean mixtures at lower altitudes.

When a sharp rate of descent is necessary, apply carburetor heat, reduce power and diminish your IAS to 150 mph; extend the landing gear and trim the aircraft as required. Maintain your desired rate of descent by varying the power settings. The propeller controls may be left in the cruise rpm position.

NOTE

Unless you are a rated instrument pilot with recent instrument experience in the type airplane you are flying, stay out of IFR conditions; however, if you are caught in such conditions, lower the landing gear before entering a cloud bank.

As you attain your new cruising altitude retract your landing gear, if lowered, reset your power settings as applicable to your particular altitude, and position the carburetor heat controls as necessary. Re-trim the aircraft and lean the mixtures as required.

CLIMB EN ROUTE

Where circumstances require ascending to a new cruising altitude, apply full throttle for all climb power settings provided you are operating above 5000 feet. Full throttle will be necessary since

your engine power decreases slightly, at a steady rate, as your altitude increases.

For a normal cruising climb, which will require only slight power increases over your cruise settings, use an engine speed between 2450 and 2500 rpm, with an IAS of 130 to 140 mph.

For best rate of climb, which may be used to quickly gain altitude or pass through an undesirable level, use 2700 rpm and the climb speed shown in the graph for your particular altitude.

After you have reached your new altitude and attained the desired cruising speed, adjust your power as required; trim the aircraft and lean the mixtures.

STALLS AND SLOW FLIGHT

The stability and handling characteristics of the Travel Air are better than average in all stall configurations and during slow flight maneuvering. Only conventional control movements are required throughout these maneuvers in maintaining the desired aircraft attitude, and all the controls remain effective. Aileron control remains particularly good throughout the entire stall.

During a normal stall approach, a slight buffeting will provide sufficient warning to permit a normal recovery; the severity of these warnings will increase slightly with power on. In addition, a stall warning indicator gives visual and aural indication of an impending stall approximately 4 to 6 mph above the actual stall.

The best recovery to level flight, with the least loss of altitude, generally may be made by lowering the nose and smoothly applying power. Diving to regain airspeed is not necessary or advisable.

SPINS

A spin is a prolonged full stall in which rapid rotation around the center of gravity, while descending in a nose down attitude, prevents the aircraft from recovery. Intentional spinning is prohibited, but if a spin has been accidentally entered, a recovery may be accomplished using basically the same procedure as used for any other full stall, except that power should not be applied during the pull out due to the existing nose down attitude.

If a spin is entered inadvertently cut the power on both engines, apply full rudder opposite the direction of rotation and then move

elevator forward until rotation stops. When the controls are fully effective, bring the nose up smoothly to a level flight attitude. Don't pull out too abruptly.

AEROBATIC FLIGHT

The Travel Air is licensed under NORMAL category limitations and is intended for only nonaerobatic, nonscheduled passenger and cargo operation. Only those maneuvers incidental to normal flying including stalls (except whip stalls) and turns in which the angle of bank does not exceed 60° are permitted.

CAR 43:48 No pilot shall intentionally fly an aircraft in aerobatic flight carrying passengers unless all occupants are equipped with approved type parachutes.

43:48-1 Aerobatic flight, insofar as it concerns the wearing of parachutes, is considered to exist when any maneuver intentionally performed results in a bank in excess of 60° relative to the horizon, or a nose up or nose down attitude in excess of 30° relative to the horizon.

DIVING

The never-exceed speed in smooth air is 240 mph. Because of the Travel Air's clean design, speed is picked up rapidly in a nose-low attitude. Dissipation of excess speed should be carefully controlled, especially if a "red line" speed is approached or rough air is encountered unexpectedly. During a pull-out be aware of the amount of control pressure that you must use to complete a safe recovery in the altitude you have available, and the loads you can apply to the structure in a pull-out. Avoid any abrupt maneuvering or sudden application of the controls; the rate at which you change direction in part determines the G-loads imposed.

FLIGHT THROUGH ROUGH AIR

When flight through a storm area or extremely rough air cannot be avoided, the problem basically becomes one of choosing the correct airspeed for safe operation under your present weight configuration. If you maintain a high airspeed, structural damage or complete failure may result, yet you must maintain sufficient airspeed for full control. Your safe operating range, between these two danger zones, varies with the severity of the gusts: the stronger the gusts, the narrower your safe operating range.

TURBULENT AIR PENETRATION SPEEDS

GROSS WEIGHT 4000 LB.

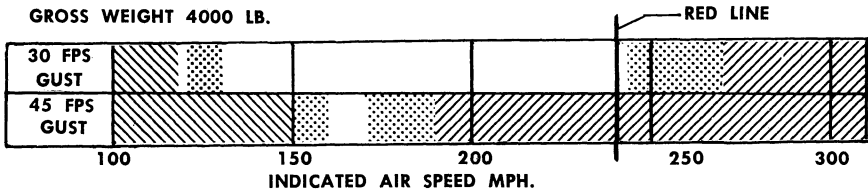

MINIMUM WEIGHT — 2775 LB.

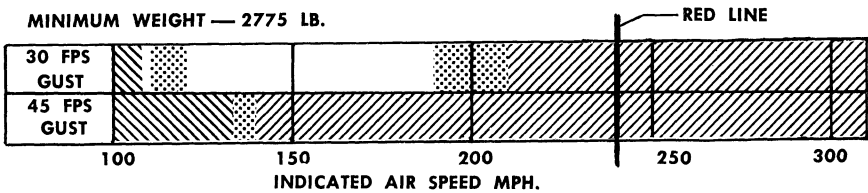

LEGEND

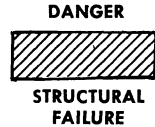
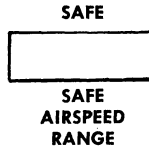

FLIGHT LOAD FACTORS

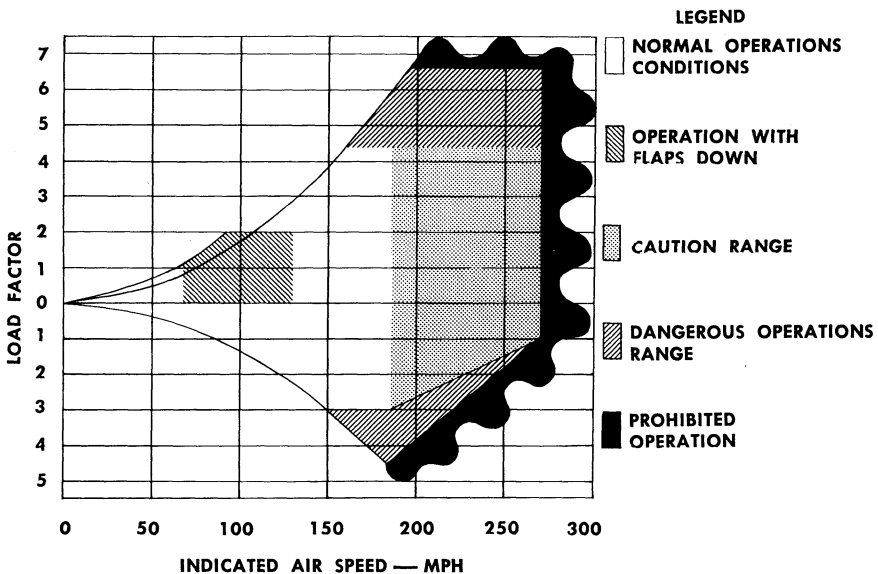

The airplane loaded weight also has some influence upon the behavior of your airplane in turbulent air and upon your safe operating speeds.

No single graph can adequately portray the effects of the gusts or turbulence upon any or all portions of the airplane. Lightly loaded airplanes undergo higher accelerations than heavily loaded ones, producing higher stress on the supports of fixed weight structures such as the engines. On the other hand, heavily loaded airplanes are subjected to greater positive wing loads but less negative wing loads than lightly loaded airplanes. The extent of these differences depends also upon the wing fuel loadings which, of course, cannot be predetermined. Therefore, two graphs appear, one for heavily loaded airplanes and one for lightly loaded airplanes.

The two gust intensities shown are for moderately heavy and severe turbulence. No graph is shown for mild turbulence. The 43-foot-per-second gusts are of the magnitude found in thunderstorm centers, while the 30-foot-per-second gusts can be encountered in frontal areas and near thunderstorm centers. Although you may operate near the design cruising speed of 185 mph IAS in ordinary rough air with a reasonable margin of safety, in any turbulence severe enough to cause discomfort to your passengers, you should slow down to approximately 130 mph IAS.

Once you have established your chosen airspeed and trimmed for level flight, you can increase the stability of the aircraft still more by extending the landing gear; the landing gear may be lowered at speeds up to 200 mph IAS, as an extreme emergency measure. If you lower the landing gear as an aid to reducing your speed, you should be alert for the changes in spiral control, elevator trim and rate-of-sink which will result, and make the necessary corrections and allowances. Lower the gear while you still are in level flight, as a preventive measure against excessive speed build-up, rather than attempting it as a corrective measure once the airplane is in a dive.

NOTE

After any emergency extension of the landing gear at high speed, the landing gear doors and supporting structure should be inspected for possible damage.

Do not lower the flaps however, unless you are letting down.

If heavy precipitation, cooler air or icing conditions which often

accompany turbulence are anticipated, keep the cowl flaps closed to maintain engine temperatures and turn on the pitot heat; always keep carburetor air temperatures in the green range on the carburetor mixture temperature indicators. If you have leaned the engines, you should place the mixture controls in full rich, switch to the main fuel cells and turn on the boost pumps since you may encounter abrupt and severe changes in altitude and attitude as you fly through the turbulence.

DESCENT AND PRE-LANDING CHECK

Either of two procedures, depending upon the situation at hand and pilot preference, may be chosen for a descent from your cruising altitude to the traffic pattern altitude at your destination. However, your pre-flight planning should have determined the procedure you intend to use. Generally a slow cruising descent starting well out from your destination is more comfortable and with the higher cruising speed attained during the shallow descent with reduced power settings, an over-all saving in fuel will result. Adverse weather, however, if encountered at these lowering altitudes might nullify these advantages and make a sharp rate of descent more profitable.

Throughout the course of the descent, watch your engine temperatures and regulate the cowl flaps accordingly. Since you will have a combination of relatively high airspeed and reduced power settings, the engines will run cooler than in level flight, and particularly in cold weather, temperatures may go below a safe minimum for full power, which you may need during your approach and landing.

CAUTION

Before you commit yourself to a landing, check for the possibility of encountering the severe turbulence in the wake of a large multi-engine or jet aircraft taking off or landing, particularly if the ground winds are light and parallel the runway. In a dead calm, this turbulence has been observed as long as several minutes after the departure of a multi-engine or jet aircraft and it may be severe enough to make even a large airplane uncontrollable.

During the final portion of the let-down and prior to traffic pattern entry, check the following items. With these checks out of the way, you will be able to concentrate on traffic pattern problems and final landing preparations.

1. Safety belts snug; shoulder harness as desired.
2. Mixture controls full rich.
3. Check main cell fuel quantity, then switch both fuel selector valves on main cells.
4. Set propellers in higher rpm.
5. Carburetor heat controls should be in the "COLD" position unless icing conditions exist.
6. Battery switch "ON."
7. Fuel boost pumps "ON."
8. Parking brake "OFF." Check brake system by depressing brake pedals and noting the resistance.
9. Set the altimeter to the local setting.
10. Check instrument readings.

Slow your airspeed to 150 mph or less as you enter the traffic pattern and extend the landing gear; increase rpm if desired and adjust the power to maintain 120 to 130 mph. Trim the aircraft as required and check the landing gear position indicators for a full down reading. Slow the aircraft from 110 rpm at the start of the base leg to approximately 90 mph as you turn on final. Flaps should be lowered as dictated by obstacles, wind, aircraft loading, and runway length and condition. Retrim as necessary for approach configuration, and maintain 90 mph either with or without power. If airport conditions will permit, at least the last 1,000 feet of final approach before crossing the airport boundary, should be straight with no turning other than minor correction maneuvers. On final approach, adjust propellers to full high rpm position.

NORMAL LANDING

Landing technique in the Travel Air is easy and conventional in all respects, due to its excellent visibility and positive control and the stability of the tricycle landing gear. As with take-off procedure, there are several satisfactory methods for landing the Travel Air under different conditions.

A normal approach and landing may be made by using full flap and holding an IAS of approximately 90 mph on final. The approach speed on final is governed by changing wind conditions, aircraft loading, weather, pilot technique, etc. As you cross the

end of the active runway, start decreasing the power settings to idle rpm and maintain sufficient back pressure to hold a slightly nose high attitude just off the runway. As airspeed is dissipated constantly increase back pressure until the aircraft settles to the runway in a nose high attitude just as stalling speed is reached. Touch down should be on the main wheels with only partial relaxation of back pressure. As speed continues to diminish, back pressure may be slowly relaxed and the nose wheel lowered gently to the runway. Apply brakes only after the nose wheel is down and avoid any hard breaking action unless absolutely necessary. On any landing retract the wing flaps near the end of the landing roll, set the elevator trim to a "0" reading and open the cowl flaps.

During high altitude landing operations, watch your airspeed closely. Don't attempt to estimate your actual speed from your rate of ground travel. While the required IAS for maneuvering at high altitude will not change, the allowances you must make in take-off and landing distances will be almost doubled at an elevation of 6000 feet as compared to the same conditions at sea level. This is due to the decrease in air density as altitude increases. The exact allowance increases you must use for your particular altitude, temperature and loading may be seen by studying the performance graphs provided for this purpose.

SOFT OR ROUGH FIELD AND MINIMUM RUN LANDING

To land the aircraft in the shortest forward distance, use full flaps and approach with as little power as practicable; maintain an approach speed of approximately 80 mph, trimming as necessary. Cross the approach end of the runway with a slightly nose-high attitude and dissipate the remaining altitude and airspeed with throttle and elevator coordination in such manner as necessary to cause the aircraft to touch-down in the shortest horizontal distance traveled, just as a stall is reached. The remaining procedure, after touch-down of the main gear, is determined by the type of landing surface used and available runway length.

On a soft field, leave the flaps down for maximum lift and braking (drag) effect, and hold the nose wheel off as long as possible. Rough field landing procedure varies only in that the flaps should be retracted immediately after touch-down if the landing surface is such that the flaps may become damaged by stones etc. thrown up by the wheels. During a minimum run landing, the nose wheel should be lowered immediately after touch-down of the main gear and the brakes applied as soon as possible.

LANDING OVER AN OBSTACLE

To approach over an obstacle, and land with a minimum of roll, your final approach must be higher than normal, both to clear the obstacle and allow you to set up your desired rate of descent. Since you will need a fairly sharp descent, use full flaps and an IAS of approximately 90 mph. Maintain your airspeed with elevator control and your rate of descent with power. Hold your airspeed within close tolerances as your sharp rate of descent will make it necessary to lead your normal flare out by a few extra feet of altitude; if necessary add power. Lower the nose wheel immediately after the main gear touches down and apply the brakes as required.

CROSSWIND LANDING

In any crosswind procedure, the principles are the same, namely: the ground track must be maintained and the side loads on the landing gear must be kept to a minimum at touch-down by aligning the wheels with the ground path. All control surfaces give normal effect, but a more pronounced degree of deflection will be necessary. Usually, flap settings should be decreased as wind velocity increase.

The recognized procedures for a crosswind landing are: slipping into the wind on final approach just enough to maintain a straight ground track and hold a heading to the intended landing strip, and by crabbing. Usually crabbing into the wind on final approach to correct for drift, and so maintain a straight track toward the landing strip, will handle a greater crosswind component than will the slipping approach. In addition the crab method maintains normal glide angles and allows the best view of the landing area.

When considerable crosswind persists all the way to the ground, touch-down on the up-wind main wheel first. Otherwise, turn to the runway heading soon enough to prevent contacting the surface with the heading you used for drift correction. After the nose gear has settled to the surface, maintain your directional control through nose wheel steering and throttles. Use the brakes only as necessary.

NIGHT LANDING

The pre-landing procedures for night operation are the same as used during a normal landing with the exception of using the different lighting elements. Many experienced pilots prefer power usage completely through the approach, flare-out and actual touch-

NORMAL LANDING

NO WIND

LANDING DISTANCE VS ALTITUDE

GROSS WEIGHT — 4000 LBS.

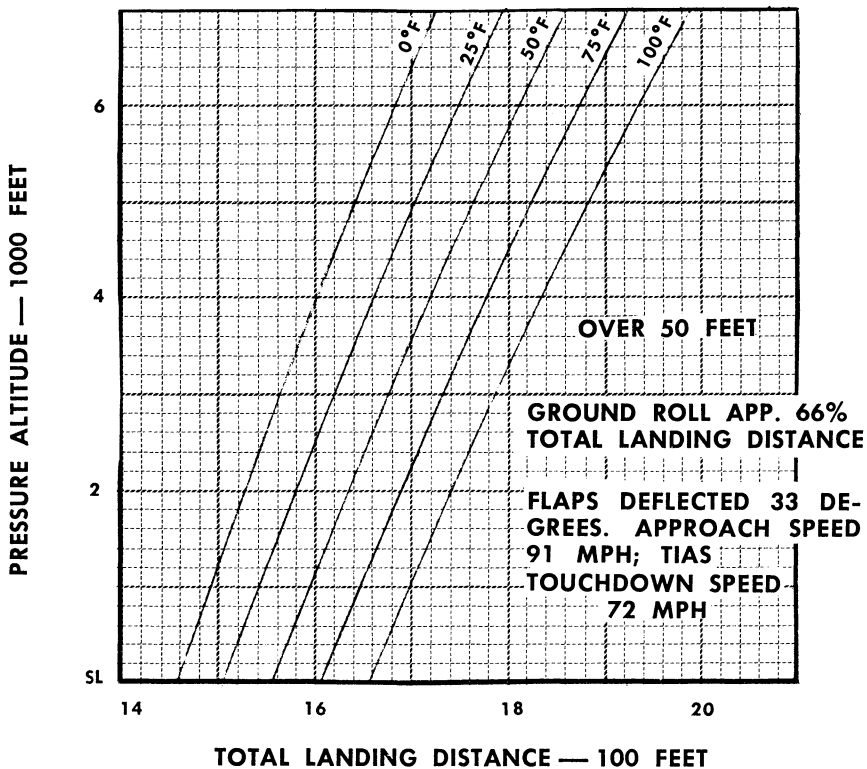

NORMAL LANDING

10 MPH WIND

LANDING DISTANCE VS ALTITUDE
GROSS WEIGHT 4000 LBS.

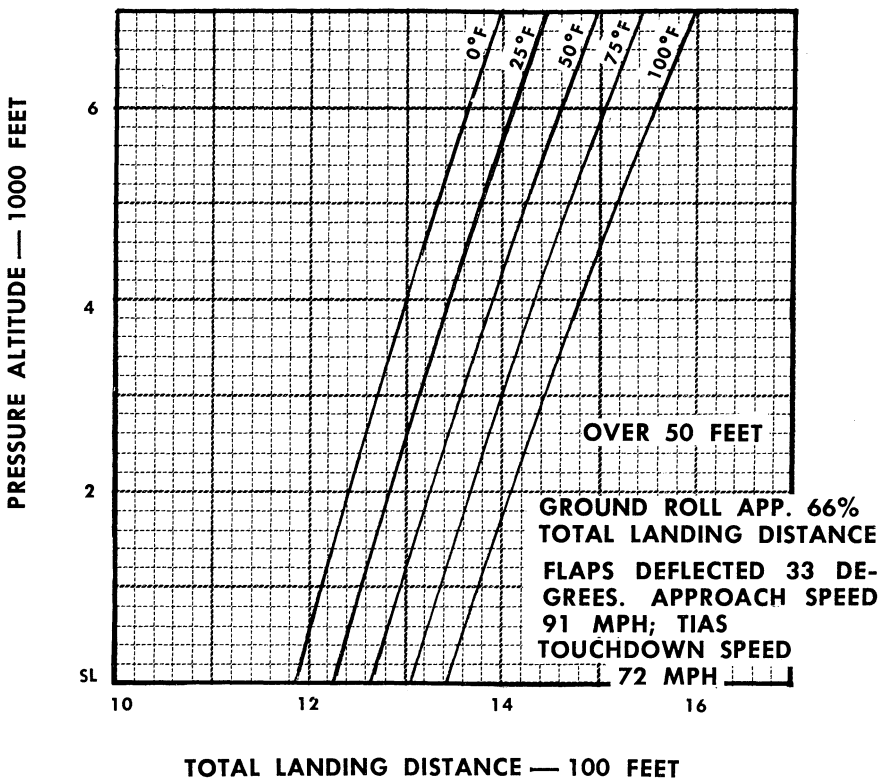

NORMAL LANDING

20 MPH WIND

LANDING DISTANCE VS ALTITUDE

GROSS WEIGHT 4000 LBS.

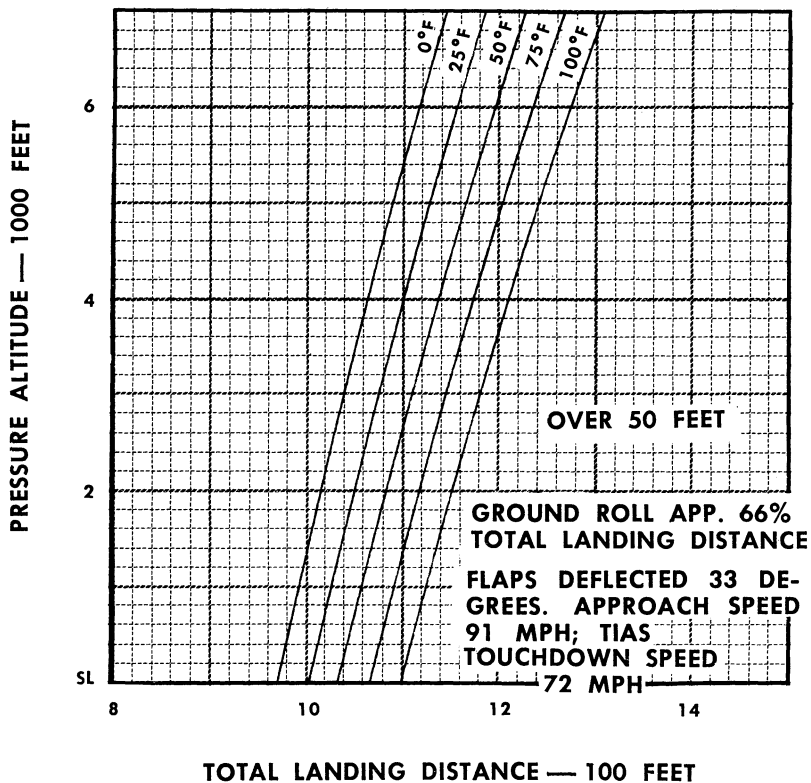

NORMAL LANDING

30 MPH WIND

LANDING DISTANCE VS ALTITUDE

GROSS WEIGHT 4000 LBS.

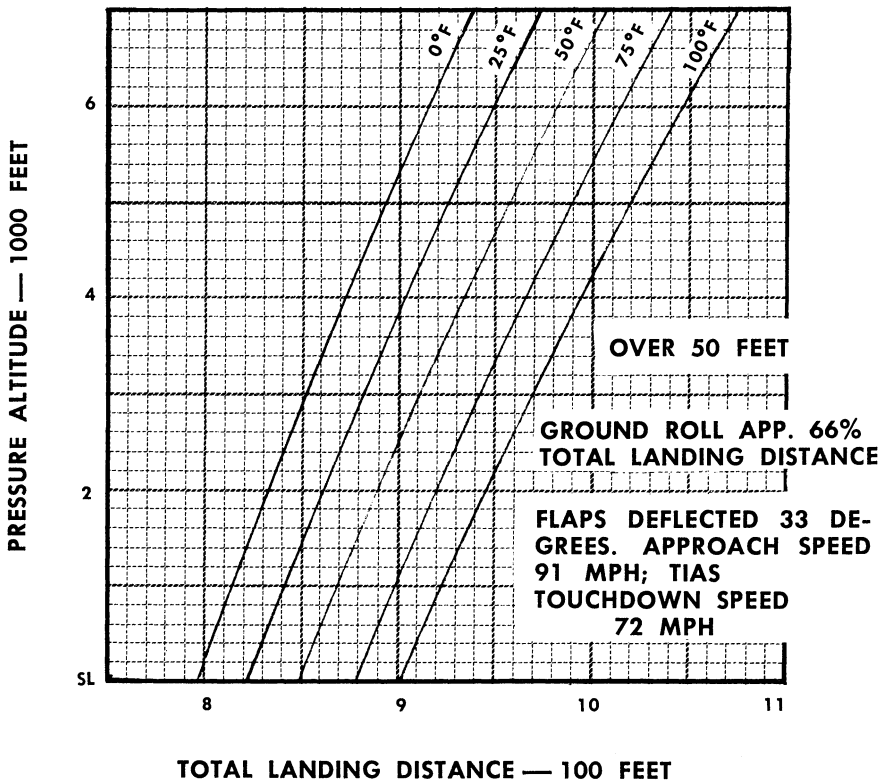

down which is most desirable when it is difficult to estimate the aircraft's exact altitude as is often the case without runway lights. By holding this partial power, the aircraft will settle to the runway in a semi-power stall; just as the ground is contacted the power should be cut-off. At any time during a power-on approach, simply by increasing power, the rate-of-descent may be reduced sharply to allow for errors in judgment or a go-around if necessary.

The use of landing lights is not always entirely beneficial as a certain glare is associated with their use, especially in hazy conditions. However, if you decide to use them, they should be turned on while the aircraft is well above the ground in order to avoid sudden changes in the appearance of the landing area as the landing position is approached. In haze it is often beneficial to use only the landing light on the side away from the pilot, to reduce the reflected glare.

BALKED LANDING

The decision to go around should never be delayed until the aircraft is near the ground in the landing position. The more altitude and airspeed remaining in the approach, the wider the margin of safety. Hence, the less chance there is of trouble.

Having decided to go around, advance the throttles to take-off power and simultaneously apply sufficient pressure to the control column to maintain a safe climb attitude for your present airspeed. Raise the landing gear, if you are solidly airborne, and push the carburetor heat controls in (COLD), if they were applied for the landing. Raise the wing flaps. However, unless it is of genuine emergency, do not raise the flaps rapidly when very close to the ground, because of the rapid loss of lift. Climb out at best angle-of-climb speed, which will vary with your pressure altitude, until you can level off safely. Remember that you are close to stalling speed; the best angle-of-climb speed is the speed resulting from an angle of attack as high as possible without stalling. As soon as you can do so safely, trim the aircraft and continue your normal climb-out procedure.

PARKING

If the aircraft is to be parked outside, if possible choose a position and heading that will nose the aircraft into the wind and at the same time avoid the propeller blast of other aircraft.

As you turn to your selected heading, roll straight ahead enough

MINIMUM RUN LANDING

NO WIND

LANDING DISTANCE VS ALTITUDE
GROSS WEIGHT 4000 LBS.

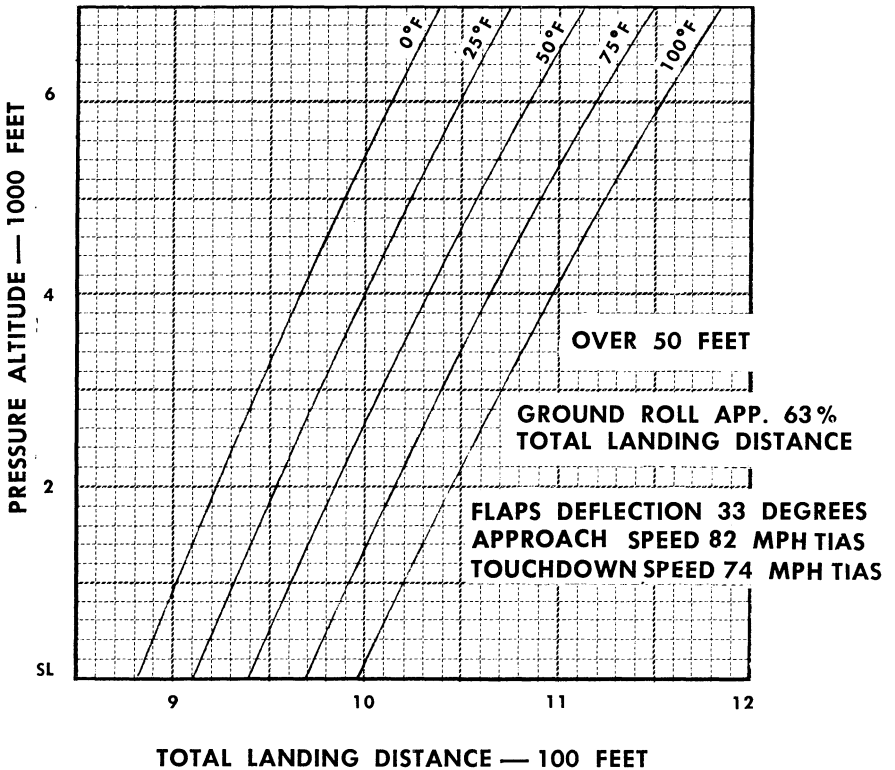

MINIMUM RUN LANDING

10 MPH WIND

LANDING DISTANCE VS ALTITUDE
GROSS WEIGHT 4000 LBS.

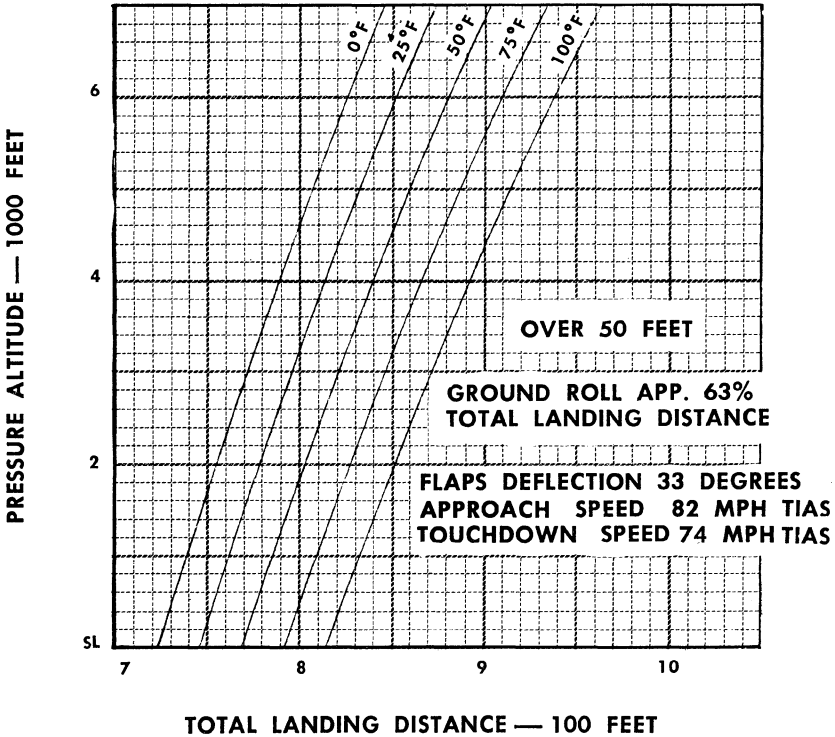

MINIMUM RUN LANDING

20 MPH WIND

LANDING DISTANCE VS ALTITUDE

GROSS WEIGHT 4000 LBS.

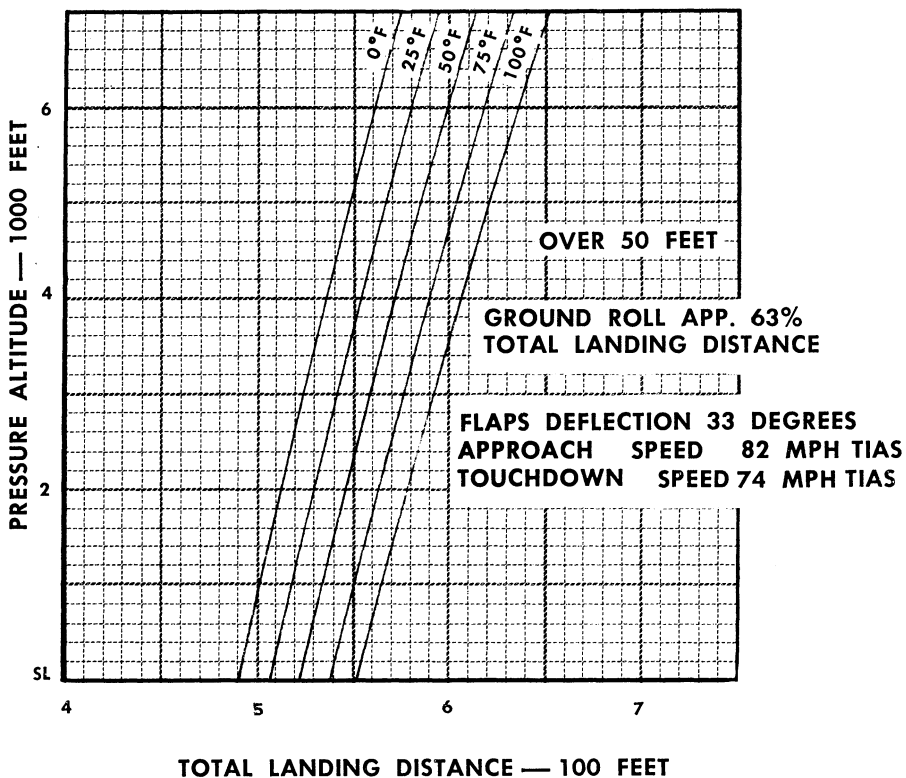

MINIMUM RUN LANDING

30 MPH WIND

LANDING DISTANCE VS ALTITUDE
GROSS WEIGHT 4000 LBS.

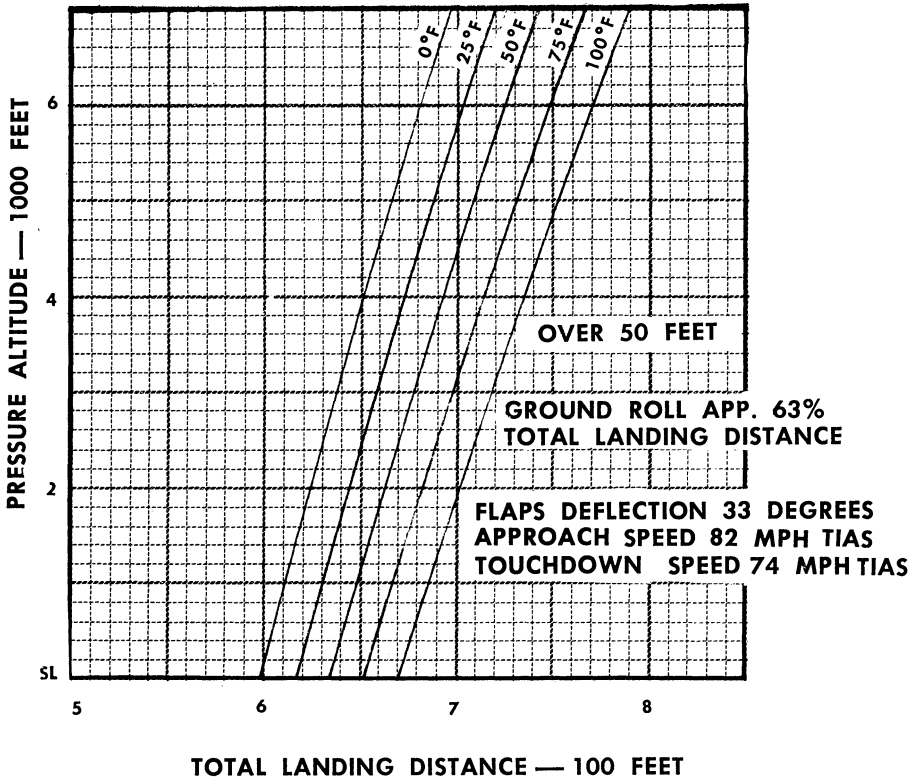

to straighten the nose wheel. Since the nose wheel steering system and the rudder system are interconnected, straightening the nose wheel will also neutralize the rudder, lessening the chances for rudder damage from wind or propeller blast.

Set the parking brake before you run up the engines for shut down. If you have used an abnormal amount of brake in taxiing, allow the brakes to cool before setting the parking brake; otherwise, the contraction of the brake discs and linings as they cool may leave insufficient pressure to hold the aircraft.

STOPPING ENGINES

Check all instruments for readings within specified limitations. If cylinder head temperatures are excessive, advance the throttles to approximately 1300 rpm until the temperatures are normal. If your temperatures are normal, turn off the radio equipment, heater and fuel boost pumps, and advance the throttles to an engine speed of approximately 1500 rpm. Position the propeller controls in low pitch (high rpm) and pull the mixture controls back to the idle cut-off position. As the engines slow, move the throttles to the full aft position until the engines quit firing. Switch off the magneto switches after the engines have stopped rotating and re-check the panel for all desired switches and controls in the "OFF" position. The fuel selector valves may be turned off; however, it is not necessary to do so since no fuel will escape from the carburetor with no fuel pressure and the mixture controls in the idle cut-off position.

SECURING AND GROUND MANEUVERING

Unless the wind is calm and the aircraft is to be left unattended for only a short time, you should install the control lock. Never leave the cabin door standing open. If you are to remain parked for more than a few hours, the pitot cover, wheel chocks and tie-down lines should be installed.

For hand maneuvering on the ramp or into a hangar, the hand towbar gives sufficient leverage to turn the nose wheel for steering. Remember, never push or pull on the propellers nor, except at their root sections, on the outboard wing panels or the tail group. In using the towbar, do not exceed the nose wheel turning limits.

ALL WEATHER OPERATION

The operation of the Travel Air under adverse conditions, due to temperature and meteorological circumstance, is relatively easy provided proper preflight planning and piloting proficiency are

employed. Some specific procedures and checks, for a more efficient operation under these variables, are presented in the following paragraphs. However, these discussions must be largely general in nature due to the variation of situations that will be encountered from time to time. ANY procedures or checks, within the bounds of good operating practice and safety, should be used for particular situations if they will prove beneficial to the intended operation.

Flight in icing conditions should not be attempted as there are no provisions for the wing and empennage deicing.

HOT WEATHER PROCEDURES

When operating under extremely hot conditions, the main cause of aircraft damage is usually dust and wind. Dust clouds in the desert may be found at altitudes up to 10,000 feet. Therefore, particular attention must be given to keeping the carburetor air intake filters clean and well oiled.

When parking or leaving the aircraft, install the pitot cover and any other dust preventive shields as required. Leave at least one window slightly open to aid air circulation and avoid excessive cabin temperatures.

Fuel and oil servicing must also receive special attention. In addition to being sure that the aircraft and all fueling equipment is well grounded, take special pains to prevent the entry of dust or sand into the fuel and oil system requires special attention.

Engine starting procedures are normal. However, ground operation must be held to a minimum since high engine operating temperatures will be attained quickly. Cylinder head temperatures especially will require close attention. During take-off, remember that the maximum power developed by your engines will be less than rated due to the high temperature of the inducted air.

The effect of excessive heat on the actual flying of the aircraft is in the form of reduced wing lift which results in decreased climb performance and longer than normal take-off and landing runs, therefore, always start from the end of the runway.

COLD WEATHER PROCEDURES

Proper pre-flight planning and the correct and more demanding care of the aircraft's systems are the backbone of your cold weather operation. If possible, the aircraft should be hangared in a warm area. However, if secured outside in sub-zero temperatures, certain

precautionary measures should be taken in addition to a most thorough pre-flight inspection prior to each operation.

NOTE

If extremely cold temperatures are expected, it is a good idea to remove the battery from the aircraft and store it in a warm place; in addition to protecting it from freezing, its output will be higher when it is re-installed.

In addition to the normal pre-flight exterior inspection, remove ice, snow, and frost from the wings, tail, control surfaces and hinges, propeller, windshield, pitot tube, fuel cell filler caps and fuel and oil tank vents. If you have no way of removing these formations of ice, snow, and frost, leave the aircraft on the ground, as these deposits will not blow off. The wing contour may be changed by these formations sufficiently that its lift qualities are considerably disturbed and sometimes completely destroyed. Complete your normal pre-flight procedures including a check of the flight controls for complete freedom of movement.

Conditions for accumulating moisture, in both the engine oil sumps and the fuel cells, are most favorable at low temperatures due to the condensation increase in the tanks, and the moisture that enters as the systems are serviced. Therefore, close attention to draining the fuel cells and oil sumps will assume particular importance during cold weather.

Engine oil viscosity weights should be changed according to the oil weight and temperature table, provided a sufficient amount of your flying is going to be in cold weather. Under extremely cold conditions it may be necessary to pre-heat the engine oil prior to a start. Always pull the propeller through by hand several times to clear the engine and "limber-up" the cold, heavy oil before using the starter. This also will save battery energy if an auxiliary power unit is not available.

Normal engine starting procedures will ordinarily be used, with the exception of priming which will probably require an extra few shots. Use carburetor heat as necessary for smooth engine operation during the warm-up period. If there is no oil pressure within the first 30 seconds of running, or if oil pressure drops after a few minutes of ground operation, shut down and check for broken oil lines or radiator.

Cold engine starts normally require a more retarded throttle setting than usual. Also, moisture forms quickly on the spark plug elec-

trodes during cold weather starts, so if you have made three or four unsuccessful starting attempts, remove at least one plug from each cylinder. Heat the plugs to dry the electrodes, replace them, and attempt a restart immediately.

Avoid taxiing through water, slush or muddy surfaces if possible. Water, slush or mud, when splashed on the wing and tail surfaces, may freeze, increasing weight and drag and perhaps limiting control surface movement.

Use your brakes with caution; taxi slowly for best control.

During warm-up, watch your engine temperatures closely since it is quite possible to exceed the cylinder head temperature limit in trying to bring up the oil temperature. According to the engine manufacturer normally the engines are warm enough for take-off when the throttles can be opened without backfiring or skipping of the engines.

During the engine run-up, carburetor heat controls should be in the "cold" position; however, if your run-up is not immediately prior to take-off, make a special check using carburetor heat, to eliminate any possible carburetor ice that may have accumulated during taxi operations or other take-off delays. Return the carburetor heat controls to the "cold" position for take-off. Turn on the pitot heat and run the propellers through their pitch range several times to flush cold oil from the actuating cylinders.

Use normal take-off procedure, but be prepared to use carburetor heat as soon as full power is not needed. Since you may have an accumulation of mud, slush, ice, etc., on the landing gear and gear doors, unless it is essential to the safety of the take-off operation, leave the landing gear down for a reasonable length of time to allow this mud, slush, ice, etc., to dry, be blown off or to freeze, reducing the chances of the landing gear or doors freezing in the up position during the course of the flight.

For in-flight operation, use carburetor heat as required and adjust power and mixture as necessary. Cycle the propellers occasionally, to flush cold oil from the propeller hubs. This action assures smoother operation, easier and more accurate power loading adjustments and minimizes the chance for cold oil to congeal in the propeller actuating cylinders. Should propeller icing be encountered, and an accumulation is resulting in rough engine operation, it can sometimes be eliminated by rapidly increasing and decreasing rpm.

During your let-down and landing, complete the normal checks and procedures, giving special attention to the engine operational temperatures which will have a tendency toward over-cooling. Keep your descent gradual; holding the airspeed within normal landing gear and wing flap operating range. If over-cooling then prevails, lower the gear and flaps, and increase the engine rpm. Use carburetor heat as necessary until reaching the landing pattern or if severe freezing conditions prevail, just prior to the flare-out.

Be prepared to change to normal air if you should need full power for a go-around.

As soon as the aircraft is on the ground retract the flaps and use the brakes sparingly.

ENGINE ICE PROTECTION

I. Cold Weather Operation

Induction system icing may occur during flight through visible moisture at plus 5 degrees C. (plus 41 degrees F.) or below. To minimize the possibility of icing, always apply FULL CARBURETOR HEAT before entering these conditions. Indications of possible icing may be engine roughness or a decrease in manifold pressure. When either of these conditions occurs in visible moisture, immediately apply full carburetor heat. Continue using full carburetor heat until you are assured that all ice has been removed and you are well clear of icing conditions. If a return to filtered air causes engine roughness, due to melting snow or ice remaining in the air scoop, return immediately to full carburetor heat. Application of carburetor heat will result in a slight loss of power.

II. Warm Weather Operation

Under certain moist atmospheric conditions it is also possible for ice to form in the mixture chamber even in summer weather. This ice may build up to such an extent that a drop in manifold pressure results. If not detected, this condition will continue to such an extent that the reduced power will cause complete stoppage. To avoid this condition, use full carburetor heat to remove the ice and then sufficient heat to prevent its reforming.

INSTRUMENTS AND WEATHER

Properly equipped, your Travel Air is an instrument airplane, but are you an instrument pilot? If you have an instrument flight rating, with recent practice in instrument flight in your Travel Air, you are. Otherwise, you are a VFR pilot. There can be no compromise on this rule, nor on its corollary: If you are a VFR pilot, don't fly in instrument weather.

The problem of the VFR pilot in instrument weather is more serious than merely getting lost and burning up all his fuel trying to discover where he is and how to get where he's going. Generally, as accident investigations have borne out, VFR pilots caught in weather don't have time to get lost. Rather, they lose control



of their airplanes, which go into turns that shortly become spirals, or into dives. The untrained pilot's efforts to correct the situation make it worse, until shortly G-loads on the airplane build up to the point of structural failure. Accidents of this type have happened with all types of modern commercial aircraft.

Even the most careful VFR pilots occasionally will encounter weather conditions beyond their piloting skill, and for this reason, a technique perfected by the University of Illinois Institute of

Aviation should be made a part of your own skill. Known as the "180-Degree Turn," it is a technique designed to return the VFR pilot to VFR conditions, safely.

Essentially, the technique consists of (1) increasing drag by lowering the gear — *in an extreme emergency the gear may be lowered at speeds up to 200 mph IAS*; (2) reducing airspeed; (3) trimming the airplane for a predetermined slow-flight speed; and (4) **WITH THE HANDS OFF THE WHEEL**, making a turn with the rudders only, to a heading 180 degrees from the heading on which you were flying when you lost visual contact.

If you lower the landing gear as an aid to reducing your speed, you should be alert for the changes in spiral control, elevator trim and rate-of-sink which will result, and make the necessary corrections and allowances. Lower the gear while you still are in level flight, as a preventive measure against excessive speed build-up, rather than attempting it as a corrective measure once the airplane is in a dive.

NOTE

After any emergency extension of the landing gear at high speed, the landing gear doors and supporting structure should be inspected for possible damage.

This technique is simple, but rapid, smooth and precise execution is essential to its success, and you should learn it from a qualified instructor, preferably in your own airplane, so that it can become completely familiar and automatic. We suggest that you contact the University of Illinois for more precise details on this procedure.

Always operate your Travel Air so that you and your passengers are comfortable; discomfort will usually appear well in advance of danger. Remember — the final responsibility for safe flight falls squarely upon your shoulders as the pilot.

Blank Page

Cruise Control

WITH the Travel Air's higher fuel capacity, higher gross weight and twin-engine utility, longer flights under more variable conditions are practical and efficient operation assumes greater importance.

The term "Cruise Control" means the intelligent flight planning and operation of an aircraft, in order to accomplish a flight most efficiently. The effects of airspeed, engine power, aircraft loading and air density, are the main factors to be considered. The calculation and execution of a good flight plan, allowing for these variables, is an accomplishment that any pilot may well be proud of.

In this section are graphs showing the performance of your Travel Air which you can use to make estimates in flight planning: true airspeeds, range and fuel consumption at various altitudes and powers and time-to-climb from sea level to various altitudes. Having made a flight plan based on estimates taken from the graphs, you should check your actual performance and review the difference between your forecast conditions and actual conditions during the flight, so that your future estimates may be more accurate.

In using the graphs, bear in mind that they have no allowances for reserves, nor for variable factors such as winds and fuel consumed in warm-up and taxiing; you must make allowances for these conditions as they actually exist from one flight to the next. Also, the flight tests from which the performance data was obtained were flown with a new, clean aircraft, correctly rigged and loaded and with engines capable of delivering full rated power. If your airplane is dirty, poorly-loaded and poorly-maintained, you cannot expect to obtain the performance indicated by the graphs. Good maintenance, such as that offered by BEECHCRAFT Certified Service Stations, will pay you dividends in actual performance as well as safety and lower over-all operating costs.

EVERYDAY CRUISE CONTROL

Consciously or otherwise, you practice cruise control on every flight you make. Whether your cruise control is good or bad — that is, whether or not it results in your getting the most from

your aircraft is determined, to a certain degree, by which method you use. The difference between cruise control for normal, or average, flights and for long range largely is a matter of degree. The principles are the same.

Normal cruise control should be used for all flying when weather and distance are well within the normal operating limitations of the aircraft and its pilot. The power settings used, however, will be governed basically by the objective of the flight — high speed, economy, or comfort. In general, your climb operations should not exceed 80% power. Level flight cruise operations should be at the lowest power that will satisfy the speed requirements, usually not to exceed 65% power. Observing these limits will normally result in the optimum balance between aircraft performance and over-all operation economy.

To obtain best engine power, the mixture may be leaned during a climb, at 80% power or less — starting at an altitude of 3500 feet. Do not lean, however, below 5000 feet at power settings in excess of 80%. Full throttle operation should be avoided below 5000 feet, with an engine speed of less than 2450 rpm.

MAXIMUM-RANGE CRUISE CONTROL

Maximum-range cruise control is the type of operation which will achieve the greatest number of miles flown per gallon of fuel used.

Cruise control for maximum range differs from that for maximum endurance chiefly in the airspeeds used. Range increases with increased airspeed, due to the improvement in aerodynamic efficiency, until the speed reaches a point where the increased drag and the proportionally-higher fuel requirements of the engines begin to offset the aerodynamic improvement. Conversely, a speed below this point also will result in fewer miles per gallon and longer flight time, due to increased drag from the less efficient flight attitude of the aircraft and a decrease in both engine and propeller performance.

This point of maximum range, in terms of optimum airspeed, must be correctly selected for a given altitude, and must be closely maintained if maximum aircraft performance is to be realized. The selection of this airspeed is complicated by several variables: altitude, wind conditions at that altitude, and propeller and engine efficiency. As shown on the range at altitude graphs, the airspeed

necessary for maximum range may be as much as 20% less than maximum cruise airspeed. In selecting the power settings you should use and in predicting your performance, you must also consider weather and terrain, since they will greatly influence your altitude choice.

MAXIMUM ENDURANCE CRUISE CONTROL

As the name implies, this is a flight technique which will keep the airplane in flight the longest time with the fuel available. To obtain minimum fuel consumption, the power is reduced to the lowest value at which the aircraft will fly and handle satisfactorily. In practice, this method of operation is used only in emergencies occasioned by weather, traffic, or other conditions. This is efficient operation only in terms of fuel consumption per hour. With reduced power, the angle of attack of the wing must be increased to maintain lift. This, in turn, produces increased drag and low flight speeds. In terms of miles per gallon, the flight operation is inefficient; it should be used only when you are going nowhere — for example, in a holding pattern. If power is increased above that for maximum endurance, efficiency in terms of miles per gallon of fuel burned will increase. Aircraft speed will increase at a greater rate than the increase in fuel consumption per hour due to the more efficient flight attitude. Thus, for any flight, the elapsed time is reduced and less total fuel will be burned than if operations were continued at maximum-endurance power.

USE OF THE GRAPHS

In cruise control, your altimeter's usual function of giving your height above the ground is of secondary importance; its chief virtue is its ability to give you barometric pressure, expressed in feet above sea level, which in turn can be converted to a measure of air density. Since air density is a major factor in all aircraft performance, the altimeter function is vital to cruise control. To permit the use of the altimeter for this purpose, the terms "pressure altitude" and "standard altitude" are used in the performance graphs.

Standard altitude, a convenient expression of air density, is the product of two variables: the actual barometric pressure and the outside air temperature. You must allow for these two factors in converting actual indicator readings into standard conditions, or translating a performance figure in the graphs into an indicator

reading under your actual conditions, since both temperature and barometric pressure vary not only at a fairly constant rate with altitude, but most inconsistently, with the weather. Presenting performance data for all the possible temperature/pressure combinations you may encounter obviously is impossible.

Pressure altitude is an expression of barometric pressure in terms of feet above sea level, rather than inches of mercury. Standard (or density) altitude, used in presenting data on range, speeds, fuel consumption and similar information, is pressure altitude corrected to a standard temperature.

In order to find your standard (or density) altitude at a given time and place, set your altimeter for a barometric pressure of 29.92; it then will read pressure altitude. Note the outside air temperature. On the altitude conversion chart, go up the line representing your air temperature to the point where it intersects the curving line representing your pressure altitude. Then read horizontally across the graph to your left to your standard altitude. You must set your altimeter to 29.92 (sea level standard pressure) in order to remove any correction in it for local barometric pressure. This correction is necessary when the altimeter is used as an altitude meter; i.e., to determine your distance above the ground. However, when you are determining pressure altitude, barometric pressure compensation will introduce an error, rather than making a correction.

If you desire to find your TAS at a particular time and place, as corrected for your current temperature and altitude, on the altitude conversion chart go up the line representing your outside air temperature to a point where it intersects the curving line representing your pressure altitude. Then read horizontally across the graph to the right along the line representing your standard (or density) altitude. There you will find a density-ratio figure. From your airspeed indicator, read your IAS, then multiply the reading by the density-ratio figure. The result will be your TAS in mph.

Like the altimeter, your airspeed indicator shows pressure, in this instance the difference between the ram air pressure imposed on the pitot tube and the ambient barometric pressure picked up by the static air ports, expressing this differential as miles per hour of indicated airspeed. Since variations in both barometric pressure and temperature will affect the pressure differential, and hence

the indicated airspeed, the data presented in the graphs has been converted to true airspeed. To find *true airspeed* you must know your *pressure altitude*, *indicated airspeed* and *ambient air temperature*.

Several airspeeds in the performance data are given as true indicated airspeed (TIAS). In these instances true indicated airspeed is preferable to true airspeed since the performance — rate-of-climb, take-off and landing speeds, etc. — is affected by barometric pressure and temperature in the same proportion as indicated airspeed so that correction is not desirable. The recommended take-off, maneuvering and landing speeds in the technique discussions throughout the book are given as IAS for the same reason. The use of TIAS in the performance graphs does not make any allowance for inaccurate airspeed indications peculiar to the individual aircraft or its operation.

The effect of temperature and pressure altitude may be seen by applying some hypothetical conditions to the Normal Take-off graph. If, for example, you take off at an altitude near sea level, when the temperature is 25°F, you can expect to clear 50 feet approximately 1820 feet from starting, assuming no wind and average piloting techniques. However, with a pressure altitude of perhaps 6000 feet and an OAT of 75°F, it will take you approximately 3750 feet to attain the same altitude.

Reference to the cruising operation graph shows that optimum cruising speed and altitude at maximum gross weight is 195 miles an hour TAS at approximately 10,500 feet standard altitude. In general, the best performance is realized at the highest altitude at which the percentage of power to be used is available, since speed increases with both horsepower and altitude. The speeds shown on the graph are based on a maximum aircraft gross weight figure of 4000 pounds; as loading and total gross weight decreases, performance and speed will increase proportionally.

In the planning phase of a flight, the cruise operation graph is to be used in predicting your performance, and in flight for checking and comparison. Selecting a cruising altitude should be the starting point in your plan. From this your standard (or density) altitude may be determined from the altitude conversion chart. (Use the standard temperature lapse rate of 2°C or 3.5°F per thousand feet

of ascent. Also, for flight planning purposes, use indicated altitude for pressure altitude; the errors will be within reason for estimating purpose.) On the cruise operation graph, locate your standard altitude and considering your gross weight, weather, winds, etc., select your intended power settings and expected true airspeed.

Once cruising altitude is reached, the actual power currently being used to hold an airspeed may be computed with the Travel Air's horsepower calculator. Thus, fly an airspeed, or a power setting — then check your performance through the calculator and graphs. Remember, the calculator is based on outside air temperature, as read from the free air instrument, not carburetor mixture temperature; an allowance has been made for the temperature rise in the intake duct.

Fuel consumption varies with horsepower and to a lesser extent with altitude, as the fuel consumption graph shows. In using the fuel consumption graph, bear in mind that the fuel flows are for specific brake horsepower and that if you expect your fuel consumption to be as estimated from the graph you must set up your horsepower accurately and make adjustments to maintain it as altitude and temperature changes occur during the flight. Also, above 5000 feet you must lean the mixtures to best power.

ALTITUDE CONVERSION

EXAMPLE: IF AMBIENT TEMP. IS -15°C AND
 PRESSURE ALT. IS 6000 FEET, THE STANDARD
 ALT. IS 4000 FEET AND $\frac{1}{\sqrt{\sigma}}$ IS 1.06

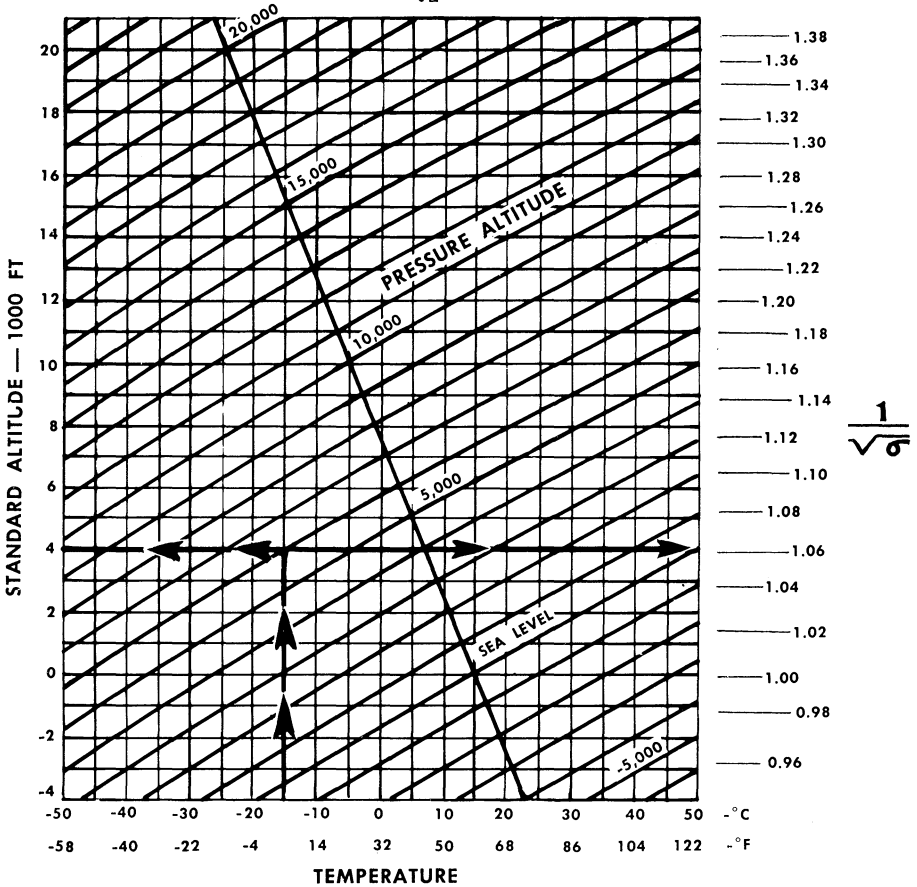

HORSEPOWER VS. FUEL CONSUMPTION

LEAN MIXTURE ABOVE 5000 FT.

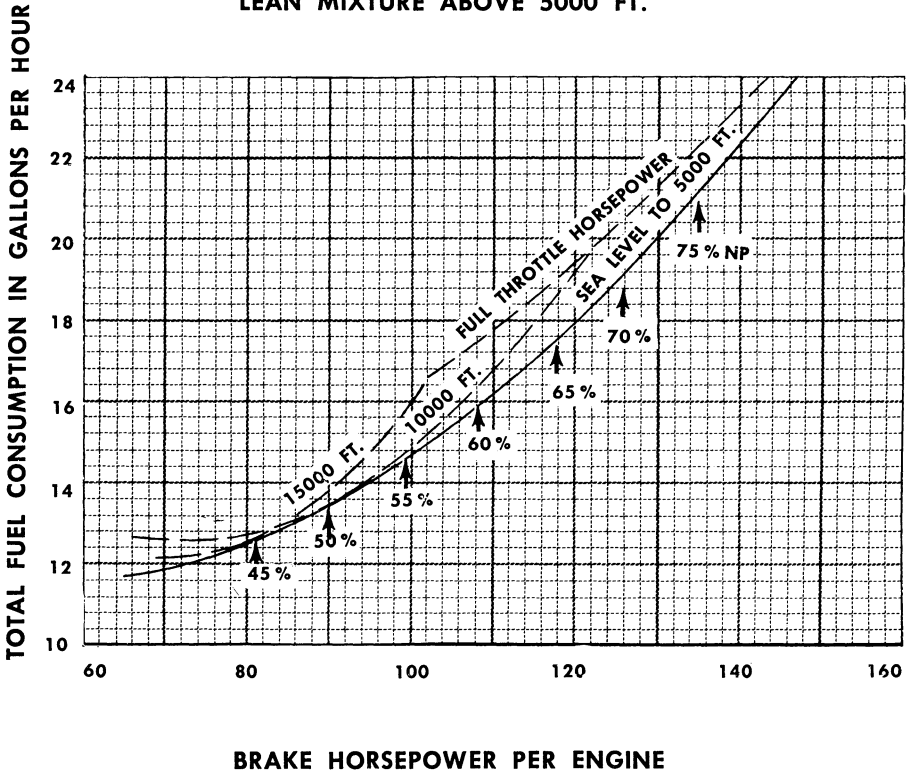

CRUISING OPERATION

4000 LBS. LOAD

*GUARANTEED @ 65% POWER AT 10,000 FT.

CRUISING OPERATION CHART AT 4000 LB.
LEAN MIXTURE ABOVE 5000 FT.

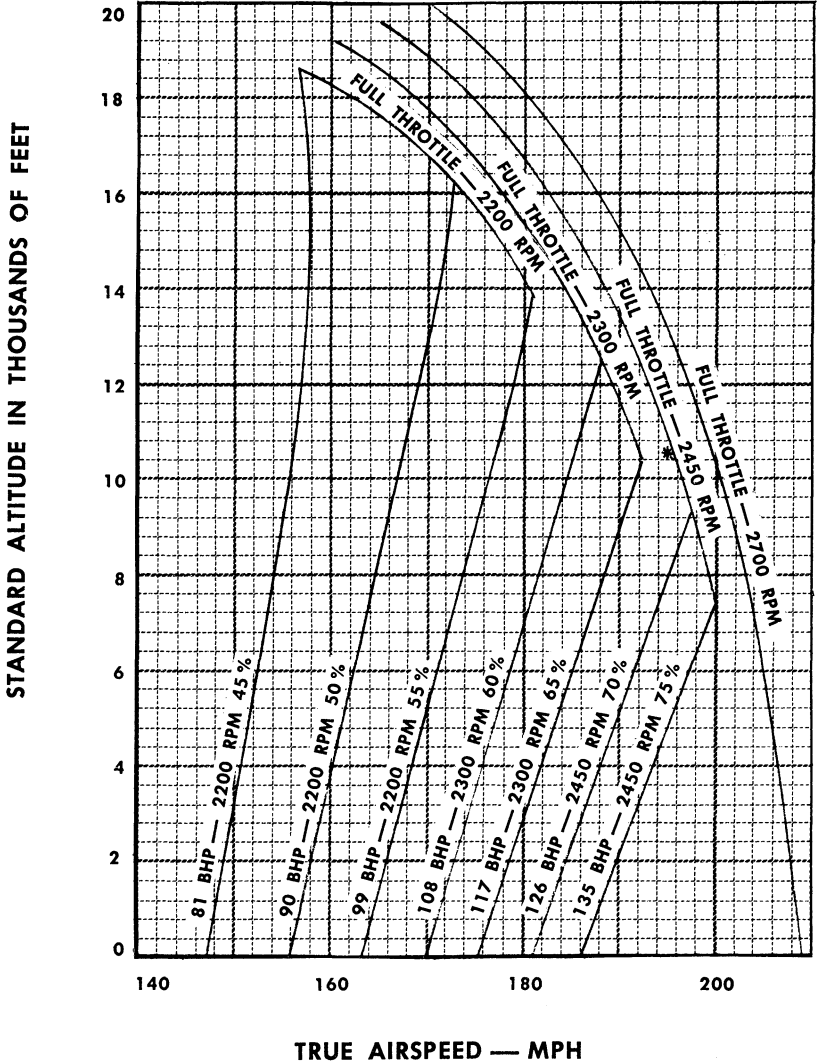

RANGE AT ALTITUDE

SEA LEVEL

RICH MIXTURE

4000 POUNDS

NO RESERVE

112 GALLONS

SEA LEVEL

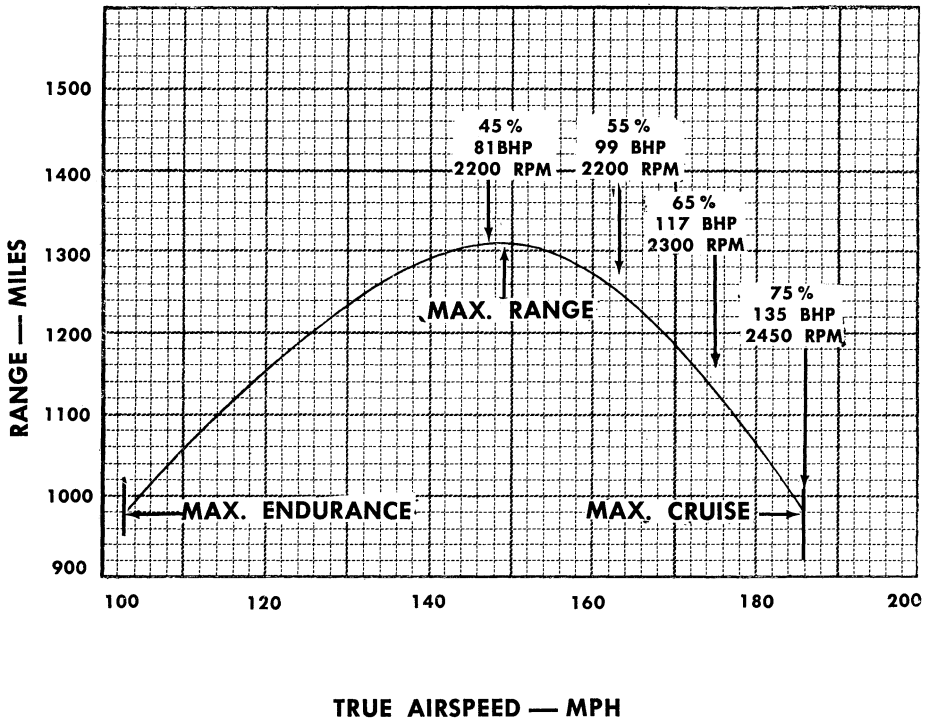

RANGE AT ALTITUDE

5000 FEET

LEAN MIXTURE

4000 POUNDS

NO RESERVE

112 GALLONS

5000 FT.

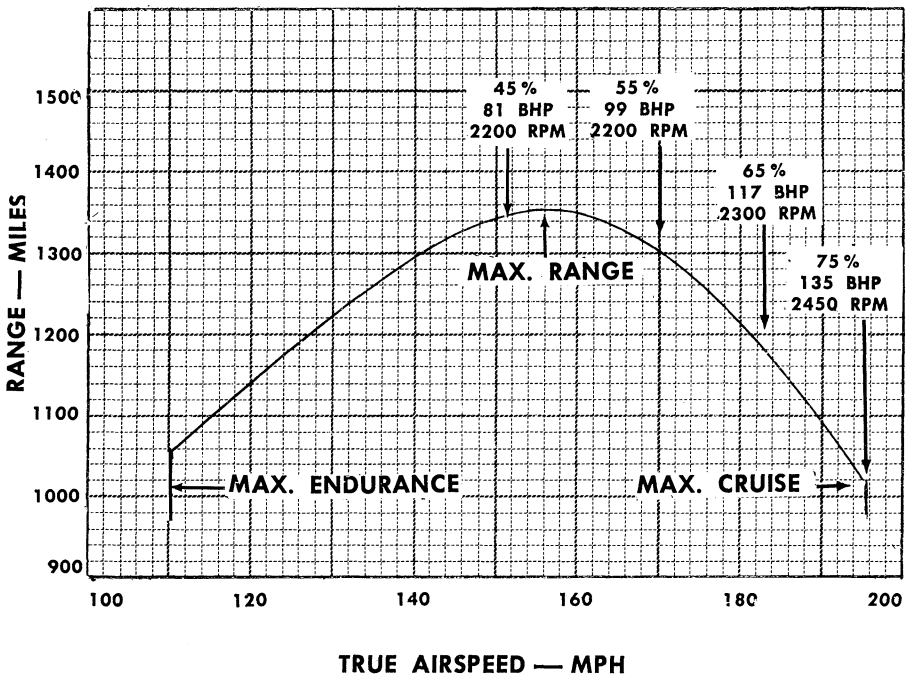

RANGE AT ALTITUDE

10,000 FEET

LEAN MIXTURE

4000 POUNDS

NO RESERVE

112 GALLONS

10000 FT.

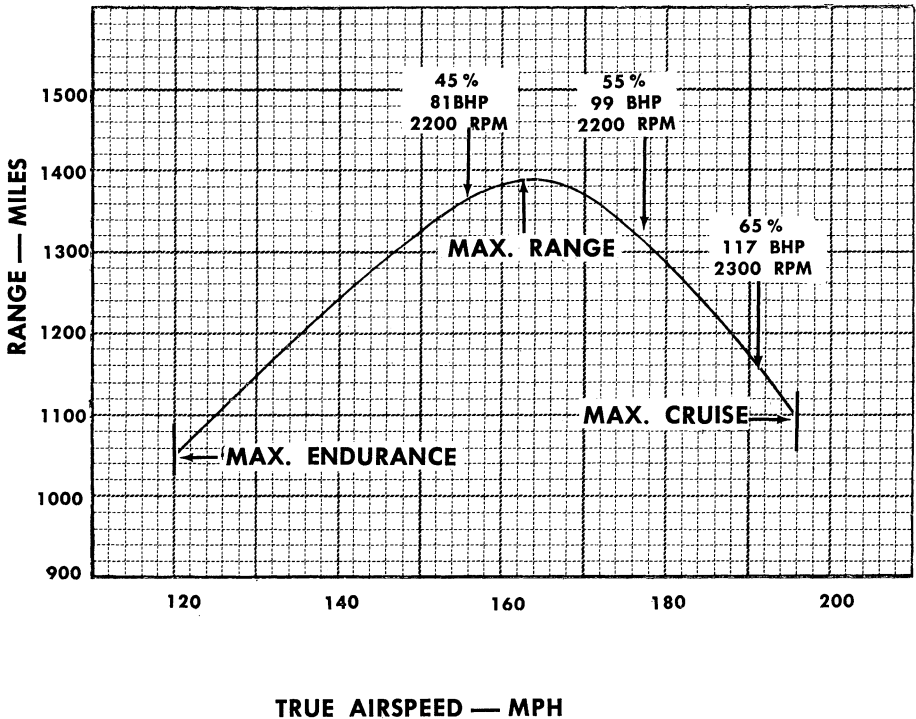

RANGE AT ALTITUDE

15,000 FEET

LEAN MIXTURE
4000 POUNDS
NO RESERVE
112 GALLONS

15000 FT.

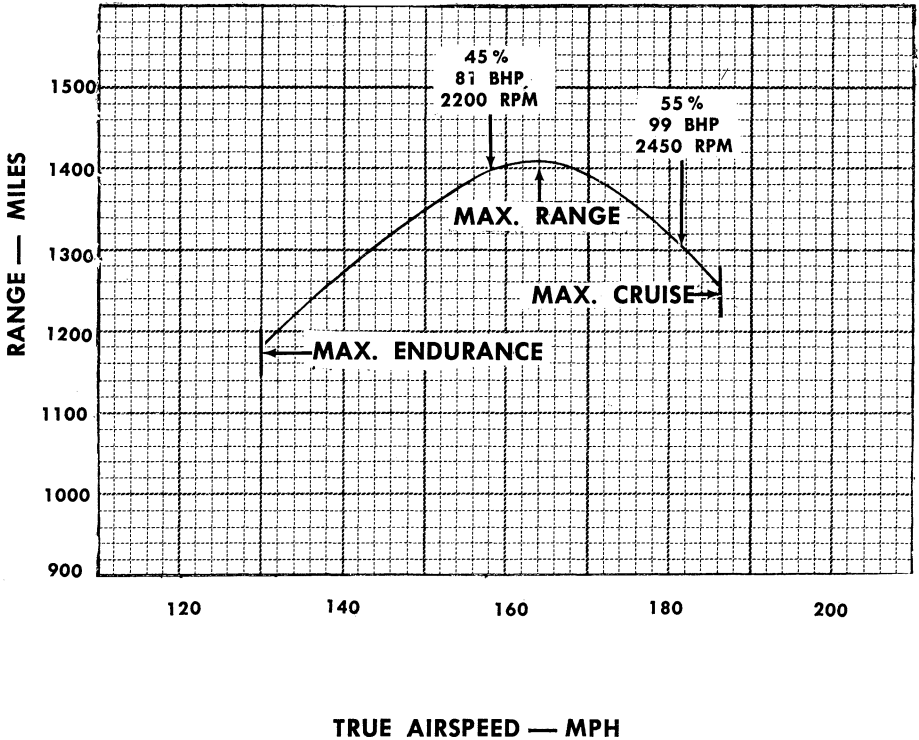



Loading Your Travel Air

YOU MAY, of course, fill the tanks, load your baggage and passengers, start up and go about your business, and as long as your loading stays within the weight limit and C.G. range, your Travel Air will fly easily and be surprisingly efficient. However, if you wish to realize the *most* your airplane is capable of giving you in fast, economical transportation, try investing a little time and effort in placing your loads to the best advantage. You will find that you can not only fly faster, but you will fly farther on less fuel.

As in flight planning, the complexity of weight and balance computations is relative: you alone, your brief case and a load of fuel should not require a check; at the other extreme, with full fuel and four people aboard, you may not be able to carry all their baggage and some high-priority cargo as well. In the following paragraphs, the weight and balance system used on the Travel Air is explained. You should study this portion of the handbook until you are completely familiar with it.

WEIGHT AND BALANCE

Careful loading will pay dividends not only in safety and handling ease, but in actual performance and over-all economy. Any departure of the center of gravity from the optimum must be compensated by elevator or elevator trim tab deflection, the amount of deflection depending directly on the gross weight of the airplane and the amount of departure from optimum of the center of gravity. Deflection of any control surface results in increased drag, sacrificing some performance and economy. Thus, while for safety's sake you must load the airplane within the center of gravity limits, for the sake of efficiency you should load it so the center of gravity is as close to optimum, or roughly halfway between the two limits, as practical. The Travel Air's two baggage compartments, one ahead of and the other behind the center of gravity, make it easier to maintain a good balance.

Since proper balance is essential to the safe operation of an airplane, a system of loading and computing the center of gravity is required by the Civil Aeronautics Administration in order to

obtain a license and certificate of airworthiness. The airplane's manufacturer must obtain approval by the CAA of the system of computing balance and the forms he will supply with each airplane. This system, plus a statement of the airplane's empty weight, empty weight center of gravity, equipment list and loading instructions then become a portion of the CAA-Approved Airplane Flight Manual, a document executed individually for each airplane and required by Civil Air Regulations to be kept in the airplane at all times.

WEIGHT AND BALANCE

The Weight and Balance portion of the CAA-Approved Airplane Flight Manual for your Travel Air contains the following information: a statement of the actual weight, arm and moment of your empty airplane, with a diagram showing the weighing and leveling points; a graph of the center of gravity limits for different gross weights; tables giving the weights and moments of fuel, oil, passengers, baggage and cargo; an equipment list giving the weights and arms of all equipment items installed at the factory and included in the empty weight; and a center of gravity table giving the limits for various weights in terms of moment. The CAA-Approved Airplane Flight Manual will be found in your airplane, usually in the pocket on the back of the pilot's seat or in the map case. Because of the importance of the information it contains, Section IV of the manual is discussed in detail in the following paragraphs and facsimiles of the forms it contains are reproduced here. A thorough study of this information will pay you substantial dividends in safer, more economical flying.

BASIC WEIGHT STATEMENT

The first page of the Weight and Balance section contains a diagram of the airplane with the datum line, jack points, leveling provisions and other information necessary to properly weigh the airplane. You will note that it lists the serial and registration number of your airplane and the initials of the technicians who weighed it and checked the computations. The form lists the actual empty weight and moment of your airplane, when it was delivered from the factory; it is with this weight and moment that your balance computations will begin. The equipment included in the empty weight is listed, along with the weight and arm of each item, in the equipment list, page 4 of the Weight and Balance section.

BEECH AIRCRAFT CORPORATION
MODEL 95 TRAVEL AIR

IV. WEIGHT AND BALANCE

Serial TD-00
Registration N000T
Computed by KES
Checked by
Date 9-16-57

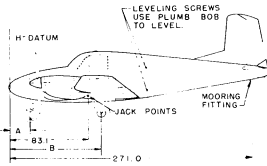

Extended A 11.8 96.0
Compressed B 13.1 97.0

Actual Weight	Scale Reading	Tare	Net Weight	Arm	Moment
Main Jack Reaction	2731	—	2731	83.1	226946
Mooring Fitting Reaction	60	153	-93	271.0	-25203
Total as Weighed	2791	153	2638	76.5	201743
Remove:					
Seat Covers			-4	100	-400
Add:					
System Oil			9	42	378
System Fuel					
Undratable Fuel			5		420
Unusable Fuel			13		1110
Air Conditioner Water			4	154	616

Empty Weight (Actual)

2665 76.5 203867

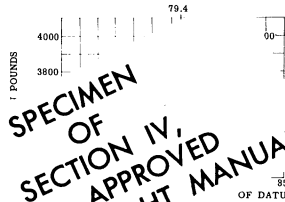

If the weight has been altered.

SPECIMEN OF SECTION IV, CAA - APPROVED AIRPLANE FLIGHT MANUAL

the airplane is loaded properly. The empty weight as delivered from the factory. If the airplane has been modified, use Form ACA-337 for this information.

WEIGHT AND BALANCE DATA - REAR SEATS

Weight	Moment / 100	Weight	Moment / 100
120	102	120	142
130	110	130	153
140	119	140	165
150	128	150	177
160	136	160	189
170	144	170	201
180	153	180	212
190	162	190	224
200	170	200	236

OIL

Gallons	Weight	Moment / 100
4.0	30	14

WEIGHT AND BALANCE DATA - BAGGAGE

BAGGAGE

Weight	Moment / 100	Weight	Moment / 100
3	10	14	14
6	20	28	28
9	30	42	42
12	40	56	56
15	50	70	70
18	60	84	84
22	70	98	98
25	80	112	112
28	90	126	126
31	100	140	140
34	110	154	154
37	120	168	168
40	130	182	182
43	140	196	196
47	150	210	210
50	160	224	224
53	170	238	238
56	180	252	252
59	190	266	266
62	200	280	280
65	210	294	294
68	220	308	308
71	230	322	322
74	240	336	336
78	250	350	350
81	260	364	364
84	270	378	378

CARGO (With Rear Seat Removed)

Ahead of Spar		Aft of Spar	
Weight	Moment / 100	Weight	Moment / 100
20	22	20	27
40	43	40	54
60	65	60	81
80	86	80	108
100	108	100	135
120	130	120	162
140	151	140	189
160	173	160	216
180	194	180	243
200	216	200	270
		220	297
		240	324
		260	351
		270	364

SAMPLE LOADING CALCULATION:

	Weight	Moment / 100
Empty Weight	2665	2039
Oil	30	14
Main Fuel	300	225
Auxiliary Fuel	180	167
Front Seat	340	288
Rear Seat	340	408
Forward Baggage	45	14
Rear Baggage	100	140
Total Takeoff Weight	4000	3289
Use Main Fuel	-150	-113
Use Auxiliary Fuel	-180	-167
Total Landing Weight	3670	3009

Serial TD-00
 Registration N000T
 Date 9-16-57

BECHCRAFT MODEL 55 TRAVEL AIR
 PAGE 4 - EQUIPMENT LIST

X - Installed in Airplane
 O - Not Installed in Airplane

Item No.	Description	Weight	Arm	Item No.	Description	Weight	Arm
X	1. Two Hartzell Full Feathering Propellers (a) Hartzell RC-9225-2 Hub with #447-12 aluminum alloy blades and 835-7 spinner (b) Woodward propeller governor, (DC10195) (c) Beech Uniflex Accumulator, 95-960011	75 ea.	22	X	303. Two landing lights, General Electric 4523	1 ea.	75
X		3 ea.	52	X	304. Paralleling relay (a) Deico-Hemly 1116902 or Lycoming 71349	1	49
X		6 ea.	65				
X	101. Fuel Pumps (a) Two electric booster pumps, Bendix 476411 (b) Two engine driven, AC type AH	2 ea.	88	X	401. DMCR Approved Airplane Flight Manual (a) Model 95 dated June 16, 1957		
X		3 ea.	53				
X	102. Two oil radiators (a) Harrison 8523517	2 ea.	30	X	402. Heater installation (a) Beech 85-550000 cabin heater installation (Modified surface combustion heater Model #3A8B)	48	22
X	103. Two carburetor air cleaners (a) Air-Maze 121128	1 ea.	33	X	403. Air conditioner installation (a) Beech 35-02025-1 (including water)	18	140
X	104. Two vacuum pumps (a) Pesco 3P-194F or Aero A513-DB	3 ea.	50	O	404. Dual control column (T-Type) Beech 35-324575	+3	72
X	105. Two starters (a) Luxcomm 71348	18 ea.	31	X	601. Stall warning indicator - Safe Flight No. 151	1	58
X	106. Two 30 gal. auxiliary fuel tanks at (93) Replacing two standard 17 gal. fuel tanks	+8	91	X	602. Heated Pitot Head Installation	1	75
X	201. Two main wheel - brake assemblies, 6.50-8 Type III (a) Goodrich Wheel Assembly No. 9531711 Brake Assembly No. 9531712	7 ea.	96		MISCELLANEOUS		
X		4 ea.	97		Instruments, Extra		
X	202. (a) Two main wheel 8 ply rating tires, 6.50-8 with regular tubes	14 ea.			Turn and bank	1	67
					Rate of Climb	1	67
					Directional Gyro	4	66
					Altitude Gyro	2	66
					Horizon Gyro	4	66
					Headsets (2)	3	100
					Hear Seat	45	124
X	205. One nose wheel 5.00-5, Type III (a) Goodrich Wheel Assembly No. 9531711 R. F. Goodrich No. 3-899				ADDITIONAL EQUIPMENT		
X					Nose Taxi Light	2	-9
X					Rotating Beacon Light	2	182
O	210. One nose wheel with cover						77
O							
O							
X							

SPECIMEN OF SECTION IV, CAA-APPROVED AIRPLANE FLIGHT MANUAL

IR WEIGHT AND BALANCE TAVITY TABLE

	Weight	Minimum Moment 100	Maximum Moment 100	Weight	Minimum Moment 100	Maximum Moment 100
2324	3200	2400	2656	3700	2844	3071
2108	2332	3210	2408	2664	3610	2747
2115	2341	3220	2415	2673	3620	2758
2123	2349	3230	2423	2681	3630	2769
2130	2357	3240	2430	2689	3640	2779
2138	2366	3250	2438	2698	3650	2790
2145	2374	3260	2445	2706	3660	2801
2153	2382	3270	2453	2714	3670	2812
2160	2390	3280	2460	2722	3680	2822
2168	2399	3290	2468	2731	3690	2833
2175	2407	3300	2475	2739	3700	2844
2183	2415	3310	2483	2747	3710	2855
2190	2424	3320	2490	2756	3720	2866
2198	2432	3330	2498	2764	3730	2876
2205	2440	3340	2505	2772	3740	2887
2213	2449	3350	2513	2781	3750	2898
2220	2457	3360	2520	2789	3760	2909
2228	2465	3370	2528	2797	3770	2920
2235	2473	3380	2535	2805	3780	2931
2243	2482	3390	2543	2814	3790	2942
2250	2490	3400	2550	2822	3800	2953
2258	2498	3410	2558	2830	3810	2964
2265	2507	3420	2565	2839	3820	2975
2273	2515	3430	2573	2847	3830	2986
2280	2523	3440	2580	2855	3840	2997
2288	2532	3450	2588	2864	3850	3008
2295	2540	3460	2595	2872	3860	3019
2303	2548	3470	2603	2880	3870	3030
2310	2556	3480	2610	2888	3880	3041
2318	2565	3490	2620	2897	3890	3052
2325	2573	3500	2631	2905	3900	3064
2333	2581	3510	2641	2913	3910	3075
2340	2590	3520	2652	2922	3920	3086
2348	2598	3530	2662	2930	3930	3097
2355	2606	3540	2673	2938	3940	3108
2363	2615	3550	2684	2947	3950	3120
2370	2623	3560	2694	2955	3960	3131
2378	2631	3570	2705	2963	3970	3142
2385	2639	3580	2715	2971	3980	3153
2393	2648	3590	2726	2980	3990	3165
				4000	3176	3320

INSTRUCTIONS

The Weight and Balance information is arranged for the airplane operator to secure the best possible loading of his Travel Air with a minimum amount of computation. The empty weight and center of gravity of this airplane is shown on Page 1 (or on the latest CAA Form ACA-337 if the airplane has been altered.) To calculate a loading, copy the current empty weight and moment, 100. (All moments are divided by 100 for mathematical convenience.) Then add the useful load items to be carried to the moment. The total weight at takeoff must not exceed 4000 pounds and the total moment, 100 must be between the limits in the Center of Gravity Table above. Then remove fuel as it would be used for the intended flight and check the total moment again to be sure it has remained within the limits for the landing condition. A sample loading calculation is shown on Page 2.

The datum, or reference line from which horizontal measurements are taken, is located 83.1 inches forward of the center line through the forward jack points. Moments of useful load items to be added to the airplane are arrived at by multiplying the weight of the item by the arm of the item, that is, the distance from the datum line to the item.

When the airplane is flown at a weight of 3480 pounds or less, the forward center of gravity limit is 75.0 inches aft of the datum and the rear center of gravity limit is 83.0 inches aft of the datum. As the weight increases, the forward center of gravity limit shifts aft in a straight-line variation to 79.4 inches aft of datum at 4000 pounds. The rear center of gravity limit remains constant at 83.0 inches aft of datum. These limits are shown on a graph on the basic weight statement.

COMPUTING YOUR LOAD

To simplify the arithmetic necessary to compute the center of gravity, in the system approved by the CAA for BEECHCRAFT airplanes, the weights and arms of the empty airplane, its items and the fuel, oil, passengers, baggage and movable equipment are reduced to moments; i.e. the products of the various weights multiplied by their respective arms. All arms are taken from an imaginary point, or datum line forward of the center of gravity. The center of gravity limits are expressed in terms of moments with the datum line as a reaction point. Thus, computing your weight and balance becomes simply a matter of adding to the empty weight and empty weight moment of the airplane, given in the basic weight statement, the weights and moments of your load — fuel, oil, baggage and passengers. The totals will be your gross weight and total moment and to see if your loading is satisfactory, you have only to compare your totals with the figures in the Center of Gravity Table. If your total weight is not in excess of the allowable gross, and your total moment is between the minimum and maximum moments shown for your total weight, your loading is satisfactory.

USEFUL LOAD WEIGHT AND MOMENTS

The tables on page 2 of the Weight and Balance section show the weights and moments of variable items such as fuel, passengers, and baggage. The empty weight moment and the moments of all useful load items are divided by 100 for mathematical convenience.

CENTER OF GRAVITY TABLE

To assist in loading the airplane, minimum and maximum moments for gross weights from 2800 pounds to 4000 pounds, in 10-pound increments, are listed in the Center of Gravity Table. These moments correspond to the forward and rear center of gravity limits at each listed weight.

The weight and moment are determined with the landing gear down. The moments given in the Center of Gravity Table are such that when the landing gear down C.G. condition falls within the limits shown, the landing gear up condition will be satisfactory also.

SAMPLE LOADING CALCULATION

1. Write down the airplane empty weight and moment/100 as referenced in the Weight and Balance section or latest Form 337.
2. Add the weight and moment/100 of all useful load items.
3. Check this loading to see that it is within the allowable limits shown in the Center of Gravity Table.

The total weight at take-off must not exceed 4000 pounds. Obviously, if the total moment/100 is outside the minimum or maximum values in the Center of Gravity Table, some useful load items must be moved, reduced, or omitted to bring the airplane within allowable limits.

4. Remove the weight and moment of fuel as it would be used for the intended flight, and check the total again to be sure it has remained within approved limits for the landing condition.

Sample Loading Calculation

	<u>Weight</u>	<u>Moment/100</u>
Empty Weight	2665	2039
Oil	30	14
Main Fuel	300	225
Auxiliary Fuel	180	167
Front Seat	340	288
Rear Seat	340	402
Forward Baggage	45	14
Rear Baggage	100	140
<i>Total Takeoff Weight</i>	4000	3289
Use Main Fuel	-150	-113
Use Auxiliary Fuel	-180	-167
<i>Total Landing Weight</i>	3670	3009

Emergency Procedures

“THE best time to know procedures and the worst time to practice them is during an EMERGENCY.”

Emergencies, created by the failure or malfunction of one or more components or accessories, may be broadly classified in one of two groups: those requiring immediate action and those in which you have sufficient time to decide on and execute a plan of action according to the demands of the particular situation.

In this discussion of emergencies, the situations requiring immediate corrective action are treated in check-list style for easy reference and familiarization. Other situations are discussed with respect to cause, condition, effect and possible corrective measures. Your practice of these suggested techniques should be frequent enough for you to maintain proficiency in the rapid initiation of the proper procedures. Complete mastery of emergency procedures peculiar to multi-engine flying cannot be over impressed.

Emergency situations seldom will occur, if you follow good inspection and maintenance practices. Otherwise your need for a complete understanding of this section is multiplied.

SINGLE ENGINE OPERATION

The flight and handling characteristics of your Travel Air on one engine are excellent. The aircraft may be safely maneuvered or trimmed for normal hands-off operation, which is easily sustained by the operative engine, *as long as sufficient airspeed is maintained*. However, to properly use these safety and performance characteristics, you must have a sound understanding of single-engine performance and the limitations resulting from an unbalance of power.

Two major factors govern single-engine operation: airspeed, and directional control. The minimum control speed, 84 mph IAS, is the speed at which you still have directional control with the aircraft in take-off configuration, one engine inoperative and full take-off power on the operating engine. However, bear in mind that this speed is a minimum for control, and *below the speed at which the aircraft will climb*.

The best single-engine rate-of-climb speed, at sea level, is 100 mph IAS (the "blue line" on the airspeed indicator). This speed is extremely important for best performance in an emergency; if the speed is allowed to vary from the optimum, your rate-of-climb will decrease, or if you are above the critical single-engine altitude, your rate-of-sink will increase. The variation in best rate-of-climb speed with altitude is shown on the graph, page 108.

The safe single-engine speed, *also* 100 mph IAS, is probably the most important speed you will be concerned with during your practice of emergency procedures and should an actual emergency occur. If you have safe single-engine speed, normal single-engine procedures may be followed. Otherwise, you must attain this necessary airspeed, through an altitude loss, or make a landing. The technique to be used in a given situation and the decisions you must make, will depend entirely upon your altitude and airspeed at the particular time the emergency arises.

These airspeeds are recommended for average piloting techniques,

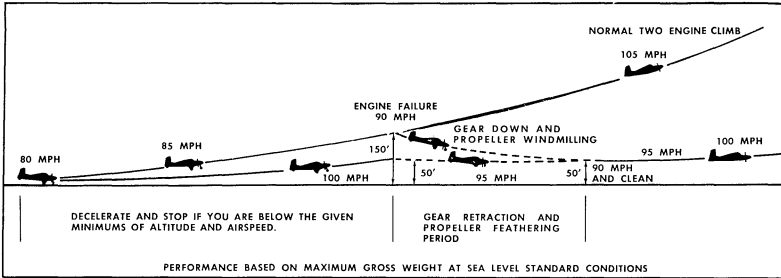

under average conditions; they do not represent the maximum aircraft performance under ideal conditions, but have been determined on the basis of actual flight tests, to afford you a reasonable margin of safety.

The chief advantage of an additional engine is the ability of the aircraft to go on flying if one engine fails. However, having two engines, like having blind flying instruments, is a safety factor which depends on the knowledge, technique and the recent experience of the pilot.

A Zero-Thrust Graph with instructions for simulated one-engine-out conditions is provided to aid in reduction of risks involved in single-engine practice. Practice these techniques until they become instinctive.

SIMULATED ONE-ENGINE-OUT PROCEDURE

Simulated one-engine-out conditions may be set up whereby zero-thrust power settings may be used instead of complete engine shut-down in order to avoid the risks involved in the training or practicing of single-engine technique. The two airspeeds represented in the accompanying graph are V_1 minimum control speed and V_2 minimum take-off safety speed with the landing gear up and the

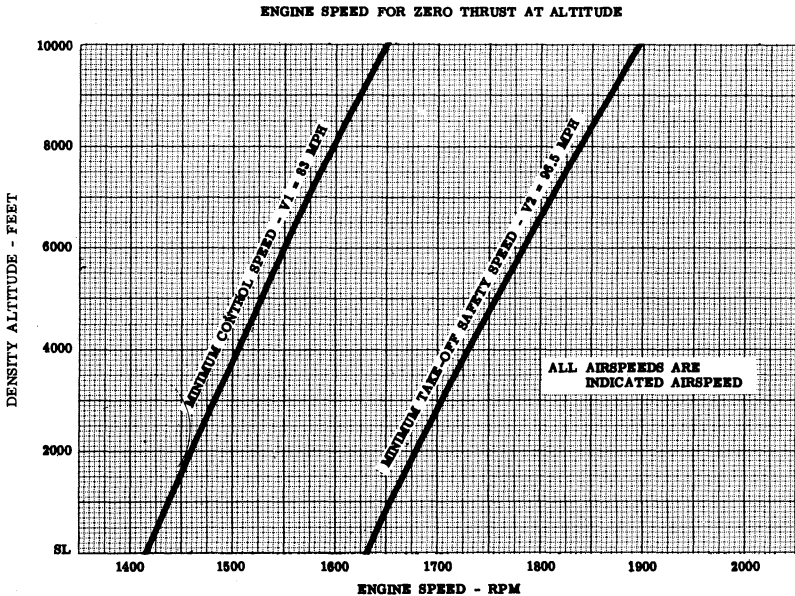

propeller feathered. In order to set up a zero-thrust condition for single engine practice, use the following procedure:

USE OF THE ZERO-THRUST GRAPH

1. Select your pressure altitude (altimeter set at 29.92 inches Hg) and either the V1 or V2 air speed.
2. Observe the OAT and determine the standard altitude from the altitude conversion chart.
3. To find the correct engine rpm, read horizontally across the zero-thrust graph at the standard altitude, calculated in step 2, to the selected airspeed where it intersects the airspeed curve, then read the engine rpm directly below.

APPLICATION

1. To obtain zero-thrust rpm, adjust power to a minimum throttle setting for the required rpm and air speed with the prop control in the full high rpm position.
2. After setting up the above zero-thrust practice conditions, single engine flight characteristics will be as set forth in the following paragraphs. The engine speed for obtaining zero-propeller-thrust can be affected quite markedly by variation in atmospheric conditions and indicated air speed. Care should be exercised in determining the standard altitude and setting up the zero-thrust power at the proper rpm and minimum manifold pressure at the air speed for the given condition.
3. For recovery after the practice condition, apply throttle and retrim as necessary.

DETERMINING INOPERATIVE ENGINE

Once an engine has actually failed, your first consideration is to continue to fly the aircraft. Apply all available power immediately: *all six levers full forward*. Then determine for certain which engine has failed, since there is a chance you may feather the propeller on the good engine. The following checks will aid you in deciding which engine has failed:

1. *Dead foot – dead engine*. The rudder pressure required to maintain directional control will be on the side of the good engine.

2. *The cylinder head temperature gage* immediately will indicate a lower-than-normal reading for the inoperative engine.

3. *Partially retard the throttle* on the engine that is believed inoperative. There should be no change in control pressures or in the sound of the engine, if the correct throttle has been selected. Under conditions of low altitude and IAS, this particular check must be accomplished with extreme caution.

Never try to determine the inoperative engine by reading the tachometer or the manifold pressure gages. After power has been lost on an engine the tachometer often will indicate the correct rpm and the manifold pressure gage frequently will indicate approximate atmospheric pressure or above.

NORMAL SINGLE-ENGINE PROCEDURE

After determining the inoperative engine, if your IAS is at or above safe single-engine speed, use the following shutdown procedure. The over-all goal of these steps is to reduce all unnecessary drag in as short a time as possible.

RATE OF CLIMB VS. ALTITUDE AND WEIGHT

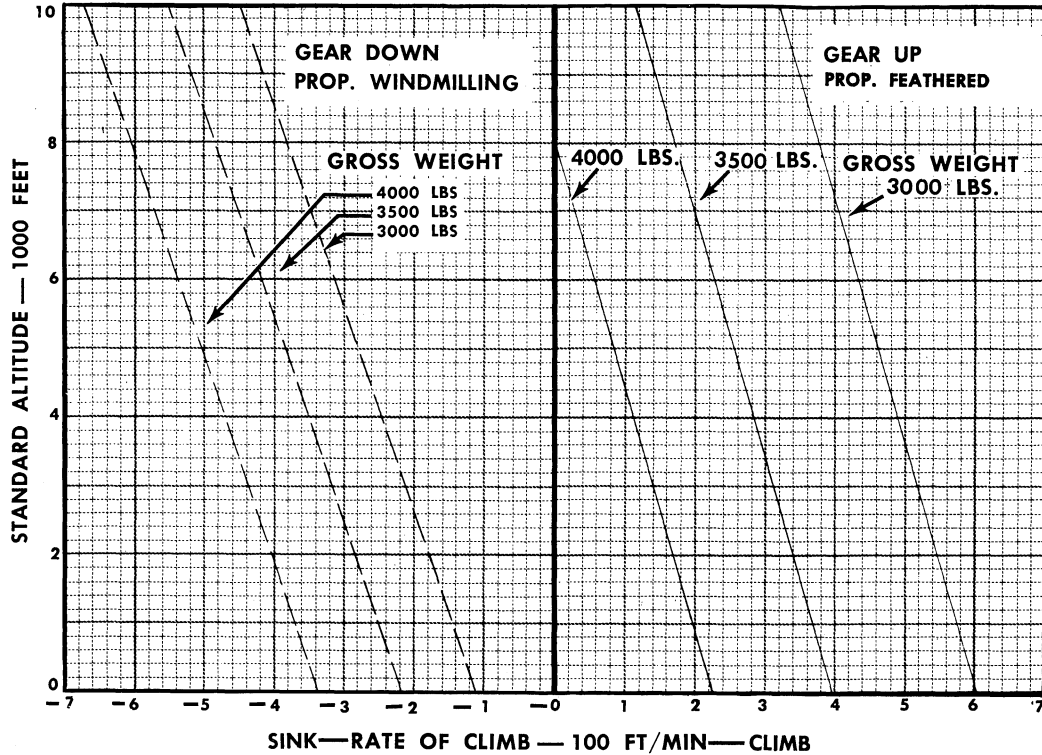

BEST RATE OF CLIMB SPEED SINGLE-ENGINE

TIAS VS ALTITUDE
GROSS WEIGHT
4000 LBS

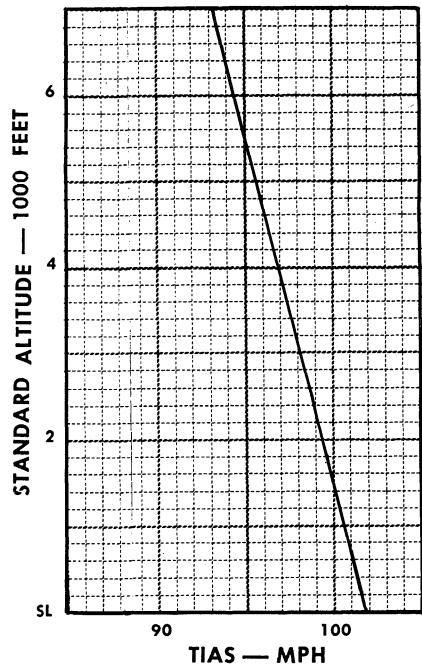

RATE OF CLIMB VS. TEMPERATURE AND ALTITUDE — SINGLE-ENGINE

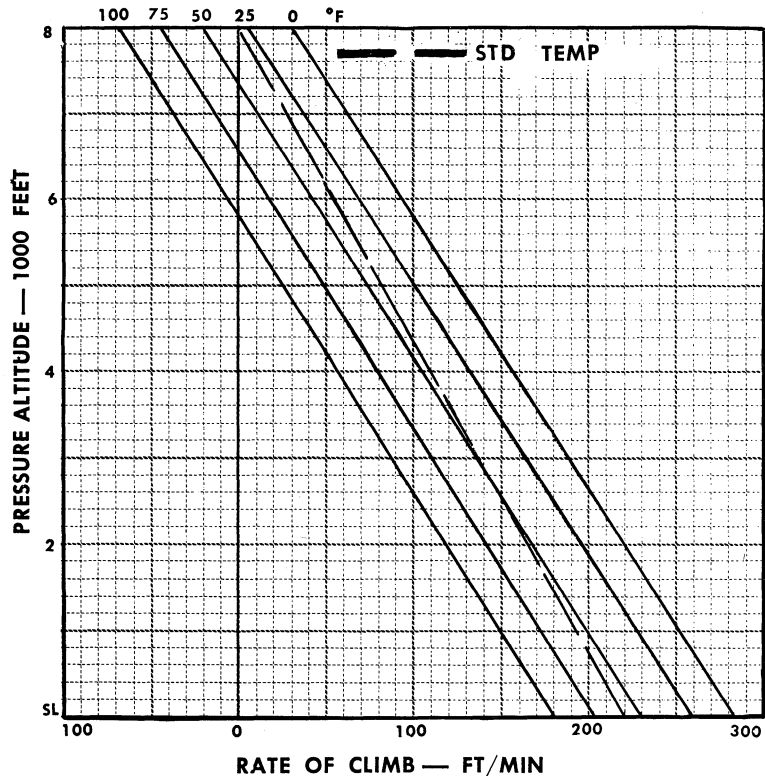

ACCELERATE AND STOP DISTANCE

DECISION SPEED
VS
DISTANCE

GROSS WEIGHT
4000 LBS.
FLAPS UP

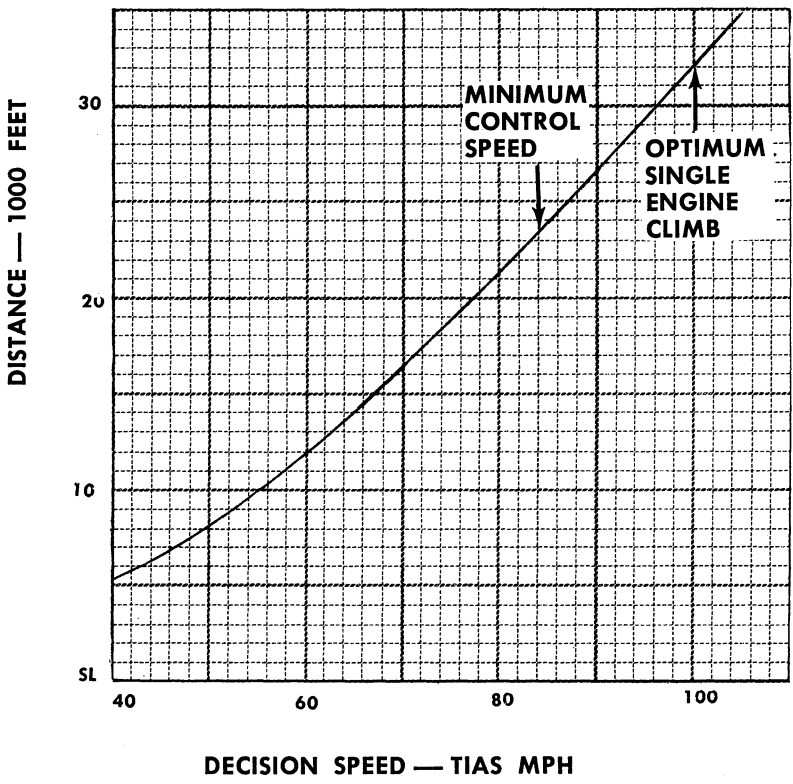

1. Apply take-off power, 2700 rpm (throttles, propellers and mixtures for both engines full forward), to obtain or maintain desired altitude and airspeed. Add rudder pressure as necessary to maintain directional control and at the same time bank approximately 5 degrees into the heavy rudder.

2. Retract the landing gear.

3. Determine which engine failed, then for the inoperative engine, pull the propeller and mixture controls back into full feathered and idle-cut-off positions.

4. Close the cowl flap on the inoperative engine.

NOTE

If flaps are in use, they should be retracted gradually particularly if your airspeed and altitude are low. This will prevent sinking that would occur due to loss of lift with fast retraction of flaps.

5. As the propeller feathers and the engine stops rotating, shut off the generator and magneto switches.

NOTE

If a propeller fails to completely stop rotating, it sometimes can be stopped by slightly decreasing airspeed.

6. Turn the fuel selector valve for the inoperative engine to "OFF," and check the fuel boost pump "OFF."

7. Turn off as much electrical equipment as necessary to prevent excessive battery drain.

8. Maintain take-off power until a safe altitude is attained or until all the single-engine procedures and checks are satisfactorily accomplished, then select a cruise power setting for the good engine which will maintain at least 110 mph IAS, the minimum speed for hands-off trim on one engine.

9. Set the rudder trim for single-engine flight and trim the wing on the side of the operative engine to hold approximately

3 to 5 degrees low. This trimming procedure will balance the drag effect of the inoperative engine with the tendency of the aircraft to turn into the good engine.

10. Land as soon as practicable.

ENGINE FAILURE DURING TAKE-OFF

The major factor in a take-off emergency, caused by engine failure, is your airspeed *at the time you decide* either to continue or to abort the take-off. The variable factors of remaining runway, obstructions in the take-off path, and the type of take-off attempted, will dictate the sequence of procedures you must follow once the decision to take-off or land has been made.

A take-off attempt should be abandoned early in the take-off run if there is any indication of malfunction or loss of power. If you are airborne, however, and landing appears hazardous, lifting the wing with the weak engine will make directional control easier.

Emergencies requiring the use of an extended landing gear are a good reason for not making an early gear retraction unless a critical situation already exists. Flaps, also, should not be used for take-off except in abnormal situations where high performance is necessary.

If an engine failure has occurred with an IAS of less than safe single-engine speed (100 mph) and the gear extended, cut your power, get the nose wheel on the runway and apply the brakes. If the aircraft cannot be stopped within field limits and ground looping is not feasible, prepare to stop straight ahead; turn no more than necessary to avoid obstructions. To minimize the chances of fire, turn off all switches and controls you can.

If an engine fails after you have gained safe single-engine speed, retract the landing gear immediately and follow normal single-engine procedure. If the failure occurs after you are airborne, but before you have safe single-engine speed, reduce power and land straight ahead. A glance at the single-engine climb graph will show clearly that the first requirement for continuing flight after an engine failure is to clean up the airplane as quickly as possible. *With the airplane clean, you can climb; with gear down, windmilling propeller and cowl flaps open, you will not be able to maintain altitude.* Bear in mind, also, that the performance shown on

the graph is for standard altitude; if your ambient temperature is higher than standard, your rate of climb will be less than that shown, while on a cold day it will be better. To visualize the amount of these variations, determine a few density altitudes based on typical summer and winter conditions and check the performance shown on the graph for these densities. Note also the effect of temperature on single-engine climb.

ENGINE FAILURE DURING FLIGHT

Follow normal single-engine procedures, if the difficulty is apparent and cannot be remedied. Otherwise, if you have a safe altitude, the following checks may be accomplished in addition to the usual procedures, in an effort to locate the trouble and resume normal operation. These checks should be made prior to feathering the propeller and turning off the magneto switches on the inoperative engine.

1. Check fuel pressure and, if deficient, turn on the fuel boost pump.
2. Check fuel quantity and switch to another fuel cell if necessary.
3. Check oil pressure and oil temperature indications; shut down the engine if oil pressure is low.
4. Check magneto switches.

If the proper corrective action has been taken the engine should re-start. Otherwise, if the cause of failure was not determined, complete the normal shut-down procedure.

Any time an engine fails, whether normal operation has been resumed or not, a landing at the nearest suitable airport and an investigation of the cause is in order.

If an engine should fail at a safe altitude and airspeed then at the pilots discretion it may not be necessary to use 2700 rpm and Full Throttle on the good engine. Power may be adjusted to produce desired performance.

RE-STARTING FEATHERED ENGINE

Prior to a re-start of an engine that has failed, the cause of failure should be located and corrected. It is wiser to continue on one engine rather than chance ruining an engine that may need only minor repairs.

The procedures given for re-starting purposes are suitable for use during practice of single-engine procedures or for a re-start after an engine failure, should you so decide. During cold weather your re-start should be completed within a few minutes after shut-down, since cold oil in the governor passages and propeller may impede unfeathering.

For engine to be started:

1. Turn the fuel selector valve to either the main or auxiliary position; the boost pump can be used on any cell selected.
2. Adjust the throttle to the normal starting position.
3. Turn on the magneto switches.
4. Move the propeller control full forward to the low pitch (high rpm) range.
5. Turn the engine over with the starter.
6. After several engine revolutions, advance the mixture control to full rich.
7. As soon as the engine starts, adjust the throttle setting as necessary to prevent an engine overspeed condition. Check immediately for fuel and oil pressure, particularly if you are restarting an engine which has failed, since the cause of the failure may be indicated by lack of, or abnormal, indications from either gage. If both do not respond normally, abandon the attempt at starting, re-feather and secure the engine.
8. After the engine starts, turn off the fuel boost pump.
9. Let the engine warm up at approximately 2000 rpm and 15 inches manifold pressure. Observe the oil pressure closely; if it does not come up to normal in 30 seconds, shut-down and re-feather.

10. When the oil temperature has come up to normal, bring the engine up to normal power and re-trim. Set the rpm first, then open the throttle.

If engine failure has been due to an actual malfunction, just prior to switching on the magnetos turn the engine over several times with the starter. If the starter will not turn the engine, an internal failure is indicated; re-feather and secure the engine.

If your aircraft is not equipped with the propeller accumulator installation, which is optional equipment, the above un-feathering procedures may still be used. However, the engine starting operation will be more difficult, particularly if the engine is inoperative for a time and has cooled down.

SINGLE-ENGINE LANDING

Essentially, a single-engine landing is the same as a normal landing, except that you should allow a larger safety margin during the pre-landing pattern and final approach. This safety margin is in the form of more airspeed, a slightly higher pattern and final approach altitude and a wider pattern which will eliminate any steeply banked turns.

Since you have more altitude, your final approach may be higher, and because of the larger pattern you may line up with the runway further out; thus, you will have time to correct for any wind drift, stabilize your final approach speed and rate of descent and judge more accurately your use of gear and flaps. Also you can ease off the power on your good engine a little sooner; rudder trim should be reduced to neutral as power is decreased.

Lower the landing gear only after final approach is established. If a base leg is used, the gear may be lowered as you roll out of the turn on final; if making a straight-in approach, aim for the first few feet of the runway and set up a glide path to overshoot rather than undershoot, then lower the gear.

With one propeller feathered, drag is considerably reduced, resulting in a longer flare-out and landing roll. Make allowances accordingly as you play your final approach.

Do not lower the flaps until the gear is down and locked and you are sure of making the field. Full flaps may be used to shorten the landing roll or to steepen the approach if you are overshooting.

With full flaps and gear down, level flight cannot be maintained at full gross weight on one engine; unless you have a safe margin of airspeed and altitude you are committed to the landing. *Unless you are light, do not attempt to go around.* Make a normal touch-down, easing power off during flare-out, but do not make a full-stall landing. Avoid making abrupt corrections with the throttle, which may induce a severe yaw.

If the landing must be made crosswind, and conditions permit, the good engine should be on the upwind side of the runway.

SINGLE ENGINE GO-AROUND

The decision to go around must be made as early as possible, since the conditions governing any single-engine go-around are critical. The more altitude and airspeed remaining in the approach, the wider the margin of safety. *A single-engine go-around may be executed at less than maximum gross weight, when it appears this is the only way to avoid a possible accident with an aircraft that has not cleared the runway. The following procedure should be used, and rapid execution of the individual steps is very important. You must obtain 100 mph IAS as quickly as possible.*

1. Apply full power, 2700 rpm, and correct for yaw as the throttle opens. Simultaneously, apply sufficient pressure on the control wheel, to hold 100 mph IAS.

2. Retract the landing gear and close the cowl flaps on dead engine.

3. If the flaps are full down, their retraction to approximately half flap is important. Since it will be impractical at this time to make a visual check on the exact flap setting in degrees, judge their position from the length of time the flap motor is running. The flaps will retract completely in approximately eight seconds.

4. Retract remaining flap as soon as practical, to obtain maximum rate of climb.

5. Trim for single-engine climb.

FIRE

The most demanding situation that may occur in an aircraft is fire. Naturally the most important task, once fire is discovered, is its elimination. Your most useful tool in this situation is a thorough knowledge of each system and its components, and the performance you can expect of the aircraft with the affected system or component inoperative.

ENGINE FIRE ON THE GROUND

During starting, engine fire may occur in either the induction or exhaust systems. In either case keep the engine turning over with the starter, in an attempt to clear or start the engine, since the fire may be blown out the exhaust or drawn through the engine and extinguished. Should fire occur:

1. Try to get engine started; open throttle and keep cranking with starter.
2. If fire does not go out and if engine does not start, place mixture control in IDLE CUT-OFF, turn fuel selector valve handle to OFF and continue cranking.
3. Turn ignition switches to OFF and release starter switch. Turn battery and generator switches OFF.
4. Signal ground personnel to use fire extinguishers, and get clear of the aircraft.

If the engine starts and fire persists or if the fire is other than in the exhaust or induction system, shut the engine down or discontinue the starting attempt; signal for fire extinguishing equipment and clear the aircraft.

ENGINE FIRE IN FLIGHT

In case of fire in an engine compartment during flight, shut down the affected engine as follows and land immediately:

1. Fuel selector valve handle – OFF.
2. Mixture control – IDLE CUT-OFF.
3. Propeller lever – FEATHER.

4. Boost pump – OFF.
5. Magneto switches – OFF.
6. Generator switch – OFF.

A procedure for establishing sufficient power for continued operation has been omitted since where a loss of altitude is not important, neither is the immediate application of more power. In other situations the loss of altitude may be as serious as the fire. Thus, you must vary your procedures as dictated by the individual problem.

FUSELAGE FIRE IN FLIGHT

Should a fuselage fire occur in flight:

1. Reduce airspeed and close off all heating and ventilating openings to minimize draft through the cabin.
2. Battery and generator switches – OFF.
3. All electrical equipment – OFF.
4. Turn battery and generator switches on separately, *after the fire is out* in an attempt to determine the nature of the fire.
5. If generator and battery circuits are all right, monitor the remaining switches one at a time to locate and isolate the defective circuit. If the defective circuit is not located, use only the minimum equipment necessary.
6. Land the aircraft immediately.

WING FIRE IN FLIGHT

If a wing fire should develop, do the following:

1. Shut-off any systems that may be contributing to the fire, or which could aggravate it, and turn off all electrical circuits to that wing.
2. Attempt to extinguish the flames by slipping the aircraft away from the fire.

3. Prepare for an emergency landing and land as rapidly as practicable.

SINGLE-ENGINE OPERATION ON CROSS-FEED

The design of the suction-type cross-feed system enables the operating engine to use the entire fuel supply of either wing. This selective usage of fuel allows you to maintain an equal weight distribution of the aircraft's fuel load, so that under single-engine operation your performance may be improved and handling may be made easier.

Once you have completed your single-engine procedures, if you desire to use up the fuel in the opposite wing cells, turn the fuel selector valve handle for the operating engine to CROSS-FEED and the dead engine's selector handle to the desired fuel cell, either main or auxiliary. You will gain more in balance and controllability if auxiliary fuel is used first, since these cells are further outboard. Remember, if both fuel selector valves are set on cross-feed, the fuel supply for both engines is cut-off. Also remember the cross-feed system is designed for level flight use.

Normally, the engine will operate satisfactorily from cross-feed but if necessary the fuel boost pump for the operative engine may be turned on to supplement the engine-driven pump.

LOSS OF FUEL PRESSURE

Fuel system difficulties usually will be noted first in the form of a pressure drop. There may be several causes for loss of fuel pressure; lack of fuel in the tanks probably is the usual cause, however engine-driven fuel pump failure, instrument failure, line breakage or leakage, and clogged screens or lines also are possible. Fuel pressure, in most instances, may be maintained with the boost pump, unless other serious malfunction exists, or is suspected, which might create a fire hazard. For doubtful situations three possible courses of action, are listed as follows:

1. **CUT THE ENGINE IMMEDIATELY** – Do this if the power is not necessary to sustain flight or to reach a safe destination.
2. **CONTINUE OPERATING THE ENGINE NORMALLY** – This may be done if you can determine unquestionably that the indicated fuel pressure drop has not resulted from a fuel leak.

3. KEEP THE AFFECTED ENGINE IN OPERATION AT OR ABOVE CRUISING SPEED WHILE MAINTAINING A WATCH FOR FIRE — This can be done if you cannot determine whether or not an actual leak exists and the engine is required either to sustain flight or maintain the required altitude for arrival at a safe destination. However, prior to power reduction for entrance to the landing pattern, cut the affected engine completely by turning its fuel selector valve to the "OFF" position and completing a normal shut-down procedure *after* the engine is dead; then make a normal single-engine landing. Unless the added power is absolutely essential to effect a safe landing, do not reduce air-speed until the affected engine is shut-down. Air flow over the engine and nacelle, due to its cooling and dispersing effect, frequently will serve to keep a fire from breaking out, even though an actual fuel leak exists — until the speed of the aircraft is reduced sufficiently, as during a landing; then, the unsuspecting pilot is confronted with a fire, too late to do anything about it.

All other factors being equal, course 1 generally is the best. However, action to be taken depends entirely upon the circumstances at the time. Such factors as the known condition of the aircraft and the remaining engine, stage and purpose of the flight, and power requirements of the aircraft should be considered.

GENERATOR AND ELECTRICAL POWER FAILURE

Electrical failures are emergency conditions in that they restrict the aircraft in some specific phases of its operation, but your prompt corrective action can greatly lessen the adverse effects of a power loss. Naturally, the sooner you detect failure the less critical the emergency is likely to become.

The loss of either engine precipitates a partial failure of the electrical power supply system and non-essential electrical equipment should be used judiciously to avoid overloading the remaining generator. Loads in excess of single generator output will drain the batteries, with the resultant loss of reserve and emergency power. Choice of equipment to use will naturally be determined by conditions; and you should be familiar with the relative current load imposed by various operating equipment, such as radio, heater and accessories such as the cigarette lighter, which has a very high drain.

A negative ammeter indication of more than a moment's duration indicates a reversal of current flow through the generator, which can damage both the generator and the battery. If such an indication appears, turn off the affected generator at once and leave it off until the malfunction has been corrected.

If both generators must be shut off, all equipment should be turned off to preserve battery power for lowering the gear and flaps; electrical equipment, such as indicator lights and electrically-operated instruments, cannot be shut-off except by turning off the battery master switch.

In the event both generators and the batteries must be shut off, boost pumps and flaps will be inoperative and the landing gear must be lowered manually. Warning horns, all indicator circuits, oil temperature and fuel quantity gages and radio navigation instruments also will be inoperative.

PROPELLER FAILURES

Most propeller failures can be attributed to one or more of the following: loss of oil supply, failure of the propeller governor or failure of the mechanical linkage between the governor and the propeller control levers. In the event of mechanical linkage failure, resulting in a runaway propeller condition, close the throttle immediately, shut down the engine and prepare to land as soon as possible. If the propeller feathers inadvertently, due to loss of oil supply, close the throttle and attempt to unfeather the propeller by operation of the propeller control lever. If all efforts to unfeather the propeller fail, shut down the engine completely.

LANDING EMERGENCIES

Landing emergencies usually are the result of an equipment failure or operational conditions which were not foreseen and taken into account at the beginning of a flight. By anticipating these emergency conditions, and through conscientious practice of the necessary procedures and techniques, the hazards of a critical situation are effectively reduced.

LANDING GEAR EMERGENCY EXTENSION

The landing gear handcrank will lower the gear manually if the electrical system fails or if you wish to do so for some other reason.

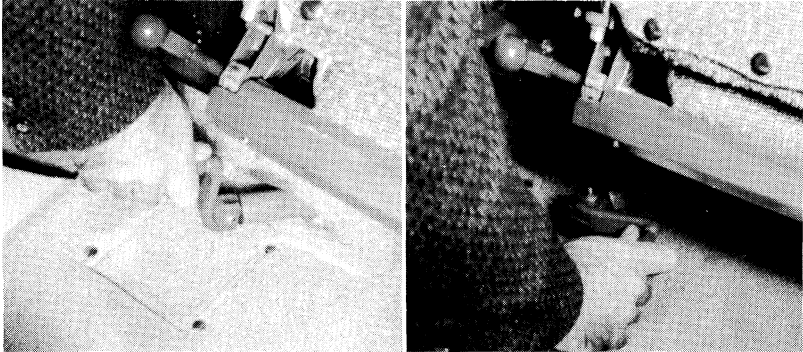

The handcrank is designed only to lower the gear; you should not attempt to retract it manually. The maximum air speed for a normal gear extension is 150 mph IAS. However, to preclude an excessive speed build-up in an extreme emergency situation, the gear may be lowered at 200 mph IAS.

NOTE

After any emergency extension of the landing gear at high speeds, the landing gear doors and supporting structure should be inspected for possible damage.

Manually extending the gear will be easier if you can reduce your airspeed first. Use the following procedure for manual extension:

1. Landing gear circuit breaker – pulled.
2. Landing gear switch – down position.
3. Remove the safety boot from the handcrank handle (at the rear of the front seat), move the handle into the cranking position, and turn it counter-clockwise as far as possible. About 50 turns will be required to get the gear down and locked.
4. Check the mechanical indicator to ascertain that the gear is down. If possible, get a visual check from the tower or another aircraft. If the electrical system is operative, you also may check the gear position light and warning horn.

FORCED LANDING

If possible, for example with a fuel shortage, land before the engines stop; landing with power will allow you to select the best area available and make a short field approach if necessary. The type of landing surface will determine whether you should land with the gear extended or retracted.

If you have a complete power failure, accomplish the single-engine procedure as applicable for shutting down both engines, but leave the battery master switch on. If the terrain is doubtful and the landing is to be made gear-up, turn the engines over with the starters until both propellers are horizontal, to reduce damage on landing. Feathering the propellers will nearly double your glide distance.

A circular descent over the field will provide the best observation of ground conditions and wind direction and velocity. When the condition of the terrain has been noted and the landing area picked, warn the passengers and check safety belts *and shoulder harness tight*. If necessary instruct the passengers in the procedure for unlocking the cabin entrance door, and pulling the emergency release pins in the rear seat main windows. Just before touch-down, have the entrance door unlocked and held slightly open to prevent jamming upon impact.

If the landing surface is of sufficient length and firmness to permit a gear-down landing, set up a rectangular pattern and lower the gear on a downwind or base leg. Use flaps as required in the approach and landing; keep in mind the variation in gliding distance if the gear is not lowered. After the flaps are lowered turn off the battery. Maintain sufficient air-speed throughout the approach to avoid a stalled condition.

MAXIMUM GLIDE

In the event of a failure of both engines, the maximum gliding distance can be obtained by maintaining 120 mph IAS, and feathering both propellers, retracting the wing flaps, landing gear and cowl flaps. The glide ratio under this configuration, as shown on the graph, is 13.6 feet of forward distance traveled to every 1 foot of descent, which will give you approximately $2\frac{1}{2}$ miles of gliding distance for every 1000 feet of altitude you have.

GLIDE DISTANCE

TIAS VS GLIDE RATIO
GROSS WEIGHT
4000 LBS.
NO WIND

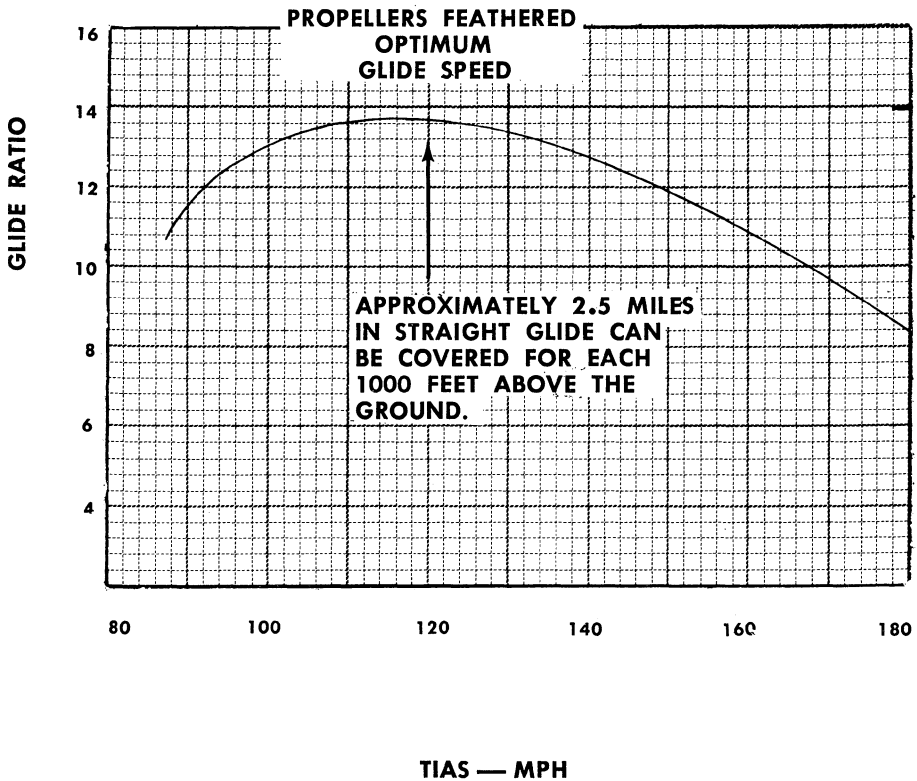

Whether you choose to land with your wheels up or down depends on the field you are going into and how much time you have to look it over before you land. A wheels-up landing will, of course, use up less distance on the ground; however, with the gear extended, the nose gear will absorb part of the shock loads from obstructions. The progressive failure of the nose structure will reduce the loads transmitted to you and your passengers. Whichever method you choose, *fasten your shoulder harness tightly.*

LANDING WITH A FLAT TIRE

A flat tire on a main wheel will act as a brake when on the ground, tending to turn the aircraft into the flat. Touch down well over to the opposite side of the runway to allow room for a swerve and hold directional control with opposite brake. A flat nose wheel tire will reduce nose wheel stability; hard applications of brake should be avoided. After landing with a flat tire, park the aircraft clear of the runway and shut down the engines; do not taxi in with a flat tire.

LANDING ON UNPREPARED SURFACES

Landing procedure for unprepared runways should be similar to minimum-run landings. If the ground is soft, use caution in applying brakes to eliminate undue strain on the landing gear and to avoid digging the nose wheel into the ground. If the ground is extremely rough, again use caution in applying brakes while crossing the rough areas. To minimize the possibility of damage from loose gravel or sod kicked up by propellers, raise the flaps as soon as possible after landing and taxi with a minimum of throttle; avoid coming to a stop in sand or other surface where considerable power might be required to move the aircraft again.

GEAR-UP LANDING

If you are to make a gear-up landing, make a normal approach and if possible, choose a hard surface to land on. During your pre-landing procedures, check the passengers for shoulder harness and safety belts tight and inform them how to unlock the cabin entrance door and pull the emergency release pins in the rear seat windows. Just before touchdown, have the entrance door

unlocked and held slightly open to prevent jamming upon impact. Use flaps as necessary to avoid overshooting the runway and flatten your glide angle. When you are sure of making the runway, close the throttles, move the mixture control levers to "IDLE CUT-OFF," cut the battery master and all ignition switches and turn the fuel selector valves to the "OFF" position. Keep the wings level and make the touchdown as gentle as conditions will permit. If possible, avoid a gear-up landing on soft ground, since sod has a tendency to roll up into chunks which may damage the aircraft structure.



Keeping Your Travel Air New

PREVENTIVE MAINTENANCE

Preventive maintenance is a program designed to keep things from going wrong, or not going at all, or quitting before they should reasonably be expected to quit.

Preventive maintenance is in part the responsibility of the airplane's owner or pilot . . . the best service facility is helpless until the airplane is in the shop with instructions to do the necessary work. The purpose of this section is twofold: first, to provide you with the information necessary for you to decide when the airplane should be sent to a shop; and second, to guide you should you choose or be obliged by circumstances to do some minor servicing yourself. It is in no sense a substitute for the services of your BEEHCRAFT Certified Service Station.

This section includes also information on ground handling, hangar clearances, oil and grease specifications and tire and strut inflation, which will be useful on a strange airport.

Carefully followed, the suggestions and recommendations in this section will help you keep your Travel Air at peak efficiency throughout its long, useful life.

BEEHCRAFT CERTIFIED SERVICE

Aware of our responsibility to our customers to insure that good servicing facilities are available to them, Beech Aircraft Corporation and BEEHCRAFT distributors and dealers have established a world-wide network of Certified Service Stations. Service facilities, to qualify for certification, are required to have available special tools designed to do the best job in the least time, on BEEHCRAFT airplanes; to maintain a complete and current file of BEEHCRAFT service publications; and to carry in stock a carefully predetermined quantity of genuine BEEHCRAFT parts. In

addition, key personnel must have factory training in BEECH-CRAFT servicing techniques, as well as CAA certificates in engine, airframe and radio maintenance. A Certified Service Station must be a CAA-approved repair station or employ an A & E mechanic with inspection authorization.

Certified Service Stations also benefit from frequently scheduled mechanics' training schools held at the factory, and from the visits of factory service representatives, to the end that their personnel are kept informed of the latest techniques in servicing BEECH-CRAFTS.

BEEHCRAFT SERVICE PUBLICATIONS

To bring the latest authoritative information to BEEHCRAFT distributors, dealers and Certified Service Stations and to you as the owner of a BEEHCRAFT, the Customer Service Division of Beech Aircraft Corporation publishes and revises as necessary the operating instructions, shop/maintenance manuals and parts catalogs for all BEEHCRAFT airplanes, as well as service bulletins and service letters. All of these publications are available from your BEEHCRAFT distributor or dealer.

SERVICE BULLETINS AND SERVICE LETTERS

BEEHCRAFT Service Bulletins and Service Letters are occasional publications dealing with improved operating techniques, revised servicing instructions, special inspections, and changes in detail parts or equipment. Service Bulletins and Service Letters differ mainly in the degree of urgency of their subject matter: Service Letters usually will announce changes or new equipment which are available for purchase if you choose, or discuss improved operating techniques; Service Bulletins, on the other hand, deal with operating techniques, special inspections, or changes in the airplane which have a direct bearing on the safety, performance or service life of your Travel Air. Service Bulletins carry definite time intervals for compliance, depending on the urgency of their sub-

jects, and you should see that they are complied with before the expiration of the allotted time. One of the services offered by BEEHCRAFT Certified Service Stations is maintaining a record of all service bulletins complied with by them on your airplane.

YOUR SERVICE INFORMATION KIT

In addition to this handbook and the CAA-approved Airplane Flight Manual, the Service Information Kit you received with your Travel Air contains a copy of the official BEEHCRAFT Certified Service Station Directory, an Abbreviated Check List, a horsepower calculator for reference in flight, several booklets discussing different aspects of flying, of general interest, and a complete set of BEEHCRAFT Safety Suggestions to date.

BEEHCRAFT CUSTOMER SERVICE

Should a special problem arise concerning your Travel Air, your BEEHCRAFT Certified Service Station, dealer or distributor will supply the information, or if necessary, he will enlist the services of factory personnel, through the Customer Service Division. His query will be answered by men who are thoroughly familiar with all parts of your Travel Air, and in addition to their own knowledge, may call on the engineers who designed it and the expert workmen who built it. The Customer Service Division maintains service records containing all information received by the factory on all BEEHCRAFT airplanes.

The work of the Customer Service Division also includes conducting service schools at the factory for BEEHCRAFT mechanics and annual Service Clinics at the facilities of various BEEHCRAFT distributors, to which you will be invited to bring your Travel Air, each year. During the Service Clinic, factory experts will inspect your Travel Air and give you a written report of their findings, without obligation to you.

GROUND HANDLING

Knowing how to handle the airplane on the ground is fully as important as knowing how to handle it in the air. In addition to taxiing, parking and mooring, you may find it necessary to maneuver your Travel Air into a hangar by hand or with a tug; or to jack up a wheel. Doing these jobs is not difficult, but if they are done incorrectly, structural damage may result.

So that you may make certain a strange hangar with doubtful clearances is adequate, the three-view drawing on page vi shows the minimum hangar clearances for a standard airplane. You must of course, make allowances for any special radio antennas you have installed; their height should be checked and noted on the drawing for future reference.

MAIN WHEEL JACKING

If it becomes necessary to replace a wheel or tire, proceed as follows: Make certain the shock strut is properly inflated to the correct height. Insert the main wheel jack adapter, furnished with the airplane as part of the loose equipment, into the main wheel axle. If the strut is not inflated to the recommended height it will be impossible to insert the jack adapter into the main wheel axle. Raise and lower the main wheel as necessary. A scissor type jack is recommended. When lowering the airplane care should be taken not to compress the shock strut, thus forcing the landing gear door against the jack adapter.

NOTE

Do not walk on the wing walk while the airplane is on the main wheel jack.

TOWING

To tow the Travel Air, attach the hand tow bar to the tow lugs on the nose gear lower torque knee. One man can move the aircraft on a smooth and level surface with the tow bar.

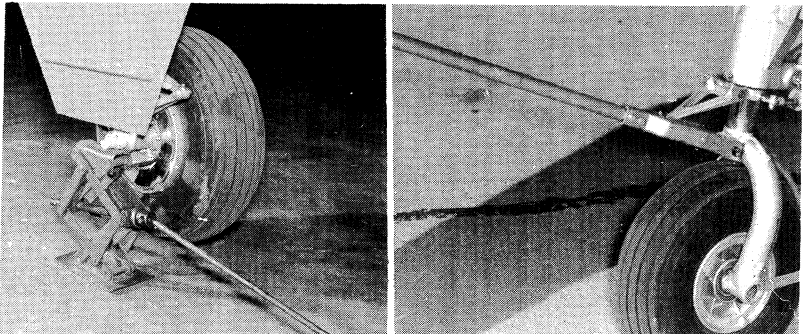

CAUTION

Do not push on the propeller or control surfaces. Do not place your weight on the horizontal stabilizers to raise the nose wheel off the ground.

To tow the aircraft with a tractor or tug, secure ropes around both main landing gear struts near the joint of the V-brace and the shock absorber. Place a man in the cockpit to handle the brakes and nose gear steering. Tow the aircraft backward to avoid fouling the nose gear, leaving sufficient clearance between the airplane and the power unit to allow the aircraft to be stopped safely. Pick up slack in the tow lines slowly and evenly, taking care to avoid jerks.

NOTE

Do not attempt to tow the aircraft backward by the fitting in the tail skid. This tail skid was designed only to protect the tail in a tail-low landing and to provide a mooring point.

EXTERNAL POWER (Optional Equipment)

Before connecting an auxiliary power unit, turn off the battery and generator switches and any other electrically operated equipment. If the auxiliary power unit does not have a standard AN type plug, check the polarity of the unit and connect the positive lead to the center post and the negative lead to the front post of the aircraft's external power receptacle. The aircraft, having a negative-ground system requires a negative-ground auxiliary power unit.

After the engine has been started and the auxiliary power unit disconnected, the electrical system switches may be turned on and normal procedure resumed.

Recharging a battery without removing it from the aircraft may be accomplished by connecting a known negative-ground auxiliary power unit to the aircraft's external power receptacle and turning on the battery master switch. In case of an extremely weak battery, removal and pre-charging may be necessary since the battery may not have sufficient capacity to close the battery solenoid. **It is essential that you make certain the power unit is negative-ground. Otherwise, a battery fire may result.**

SERVICING

The following service procedures will keep your Travel Air in top condition between visits to your Certified Service Station. These procedures were developed from engineering information, factory practice and the recommendations of engine and parts suppliers, as well as operating experience with thousands of BEECHCRAFTS using identical or similar components. They are the essence of "preventive maintenance."

MAGNETOS

Ordinarily, the magnetos will require only occasional adjustment, lubrication and breaker point replacement, which should be done by your Certified Service Station.

CAUTION

To be safe, treat the magnetos as hot whenever a switch lead is disconnected at any point; they do not have internal, automatic grounding devices. The magnetos may be grounded by replacing the switch lead at the noise filter capacitor with a wire which is grounded to the engine case. Otherwise, all spark plug leads should be disconnected or the cable outlet plate on the rear of the magneto should be removed.

SERVICING THE OIL SYSTEM

The Travel Air is provided with a wet sump, pressure-type oil system. Each engine sump capacity is 8 quarts with an absolute minimum capacity of 2 quarts required for safe engine operation. To service the oil system, open the right hand section of the cowling

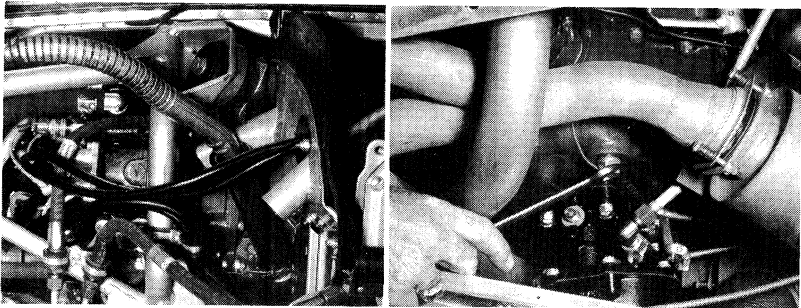

- A OIL PRESSURE SCREEN — PAGE 134
- B AUXILIARY FUEL TANK FILLER — PAGE 135
- C MAIN FUEL TANK FILLER — PAGE 135
- D FUEL SUMP DRAIN — PAGE 135
- E FUEL STRAINER DRAIN — PAGE 135
- F OIL SUMP DRAIN — PAGE 134
- G OIL FILLER — PAGE 133
- H OIL SUCTION SCREEN — PAGE 134

- I BATTERY — PAGE 141
- J AIR CONDITIONER — PAGE 138
- K EXTERNAL POWER RECEPTACLE — PAGE 131
- L CARBURETOR AIR FILTER — PAGE 141
- M STATIC AIR DRAIN — PAGE 140
- N STATIC AIR PORTS — PAGE 140

- O TIRE INFLATION — PAGE 138
- P MAIN STRUT FILLER — PAGE 135
- R NOSE STRUT FILLER — PAGE 135
- S SHIMMY DAMPENER — PAGE 136
- T BRAKES — PAGE 137

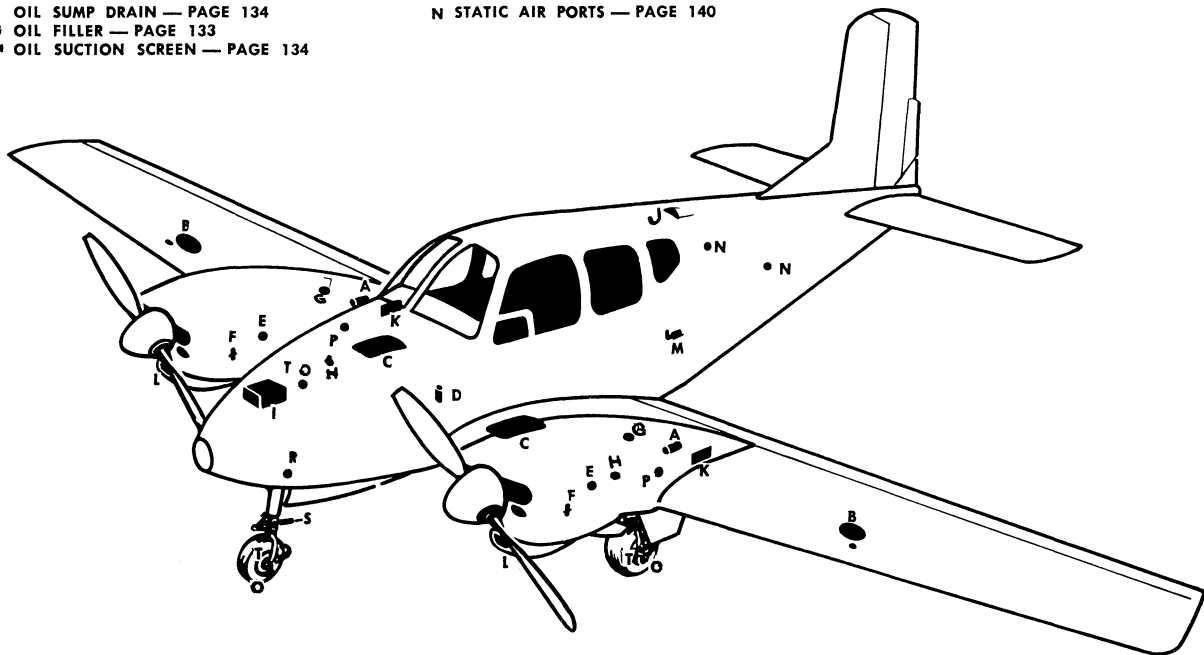

SERVICING POINTS

and remove the filler cap. On aircraft TD-174 and after access doors are provided in the cowling to service the oil system. A calibrated dip stick attached to the filler cap indicates the oil level. The oil should be changed every 50 hours under normal operating conditions. When operating under adverse weather conditions or continuous high power settings, the oil should be changed more frequently.

NOTE

The special preservative oil in the engines of the Travel Air when the airplane is delivered from the factory should be changed for normal oil after 25 hours of engine operation.

The oil may be drained by removing the pipe plug from the bottom inboard side of the oil sump, the low spot of the system. The engines should be warmed up to operating temperature to assure complete draining of the oil. Moisture that may have condensed and settled in the oil sump should be drained by occasionally removing the oil drain plug and allowing a small amount of oil to escape; this is particularly important in winter, when the moisture will collect more rapidly and may freeze.

The oil suction and pressure screens should be cleaned at each periodic oil change. To clean the suction screen, remove the hex head plug at the rear of the oil sump and pull out the screen. To clean pressure screen, remove four bolts that secure screen housing to engine accessory section. Pull housing back and remove screen. Wash the screens in Stoddard Solvent, Federal Specification P-S-661 A.

The oil grades listed below are general recommendations only, and will vary with individual circumstances. The determining factor for choosing the correct grade of oil is the oil inlet temperature observed during flight; inlet temperatures consistently near the maximum allowable indicates a heavier oil is needed.

RECOMMENDED OIL FOR MODEL 95 ENGINES

Aviation Grade Oil	Average Ambient Air	Oil Inlet Temperature	
	Temperature	Desired	Maximum
SAE 50	Above 40° F	180° F	245° F
SAE 30	Below 40° F	170° F	220° F
SAE 20	Below 10° F	160° F	200° F

NOTE

Use only non-detergent aviation grade engine oils.

During cold weather the oil sumps should be checked at pre-flight inspection to be sure that they are not blocked with ice.

Also, since there may be more cylinder blow-by during cold weather starting, with an attendant increase in oil sludge, the oil pressure screens should be checked more frequently and if indicated, the oil drain intervals should be shortened.

SERVICING THE FUEL SYSTEM

Service the fuel cells with 91/96 octane or next higher grade of fuel. A 25-gallon main fuel cell is installed in each wing stub and a standard 17-gallon auxiliary fuel cell or an optional 31-gallon auxiliary fuel cell is installed in the wing panels outboard of each nacelle. Fill each cell separately through the filler neck by removing the flush-type filler caps from the upper wing skins.

Prior to transferring fuel, ground the refueling hose to one of the aircraft grounding jacks. Open each of the eight snap-type fuel drains daily to allow contaminated fuel to drain from the system. The four sump drains extend through the bottom of the wing skins; the two selector valve drains are located at the system low spot to drain the interconnecting lines, and extend through the bottom of the fuselage center section skin; the fuel strainers are provided with drains that extend through the lower inboard cowling skins. Fuel strainers and drains on aircraft TD-127 and TD-174 and after are located in the wheel wells.

CAUTION

Never leave the fuel cells completely empty or the cell inner liners may dry out and crack, permitting fuel to diffuse through the walls of the cell after refueling. See section on storage.

SERVICING THE LANDING GEAR

The landing gear retract system is a complex system with very small clearances between working parts. Adjustments should be made only at a BEECHCRAFT Certified Service Station. Any malfunction should be corrected by a Certified Service Station.

SHOCK STRUTS

The shock struts are filled with compressed air and MIL-0-5606 hydraulic fluid. The same procedure is used for servicing both

the main and nose gear shock struts. To service a strut proceed as follows:

a. Remove the air valve cap and depress the valve core to release the air pressure.

WARNING

Do not unscrew the air valve assembly until all air pressure has been released or it may be blown off with considerable force, causing injury to personnel or property damage.

b. With the weight of the aircraft on the gear, loosen the filler plug slowly to assure that all air has escaped, then remove the filler plug.

c. With the shock strut fully deflated, jack the strut barrel $\frac{1}{4}$ inch off fully compressed, block it there and fill to the level of the filler plug hole with MIL-0-5606 hydraulic fluid.

d. Jack the main strut an additional 2 inches, then replace the filler plug, depress the valve core and lower the jack, releasing the excess oil and air. On the nose strut, merely remove the block and allow the excess oil to drain away, then install the filler plug.

e. Rocking the airplane gently to prevent possible binding of the piston in the barrel, inflate the strut to an extension of 2 inches of exposed piston (aircraft resting on the gear).

f. The shock strut pistons must be clean. Remove foreign material by wiping the strut with a cloth containing hydraulic oil.

SHIMMY DAMPENER

To check the fluid level in the shimmy dampener, insert a wire of approximately 1/16-inch diameter through the hole in the disc at the end of the piston rod until it touches the bottom of the hole in the floating piston. Mark the wire, remove and measure the

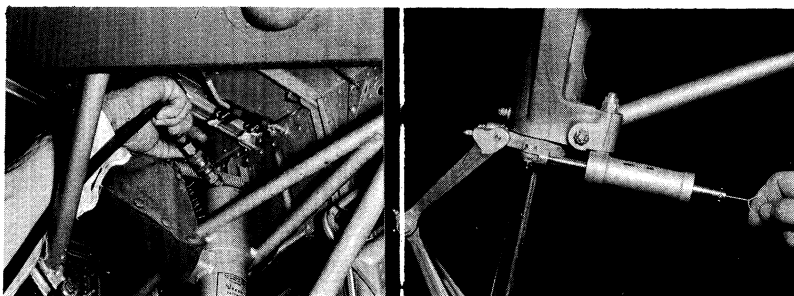

depth of insertion. Inserting the wire in the hole of the floating piston, rather than letting it rest against the face of the piston, will give a more accurate check.

NOTE

To determine if the wire is inserted in the hole of the floating piston, insert the wire several times, noting each insertion depth. When the wire is correctly inserted the length will be approximately $\frac{1}{4}$ inch greater.

When the shimmy dampener is full, the insertion depth is 2-3/16 inches. The empty reading is 3-1/16 inches. To add MIL-0-5606 hydraulic fluid remove the shimmy dampener and proceed as follows:

a. Remove the cotter key, washer, and spring from the piston rod.

b. Remove the internal snap ring, scraper ring and the end seal from the aft end of the barrel. (Opposite clevis end.)

c. Insert a 6/32 threaded rod into the floating piston and remove the piston, using extreme care when moving the "O" ring seal of the floating piston past the drilled holes in the piston rod.

d. Push the piston rod to the clevis end and fill the barrel with MIL-0-5606 hydraulic fluid.

e. Slowly actuate the piston rod, allowing the fluid to flow into the clevis end chamber, then return the piston to the clevis end of the barrel.

f. Refill the displaced fluid and replace the end seal, scraper ring and internal snap ring.

g. Fill the piston rod with fluid.

h. Reinstall the floating piston, spring, washer and cotter key. Spread the cotter pin to allow clearance for the measuring wire.

SERVICING THE BRAKES

The Goodyear single-disc, hydraulic brakes require no adjustments, as the pistons move outward to compensate for lining wear. Linings should be checked for small nicks or sharp edges which could damage the brake discs. Worn, dished or distorted brake discs should be replaced. The fluid reservoir, accessible through the forward baggage compartment, should be checked regularly and a visible fluid level maintained on the dip stick at all times by adding MIL-0-5606 hydraulic fluid.

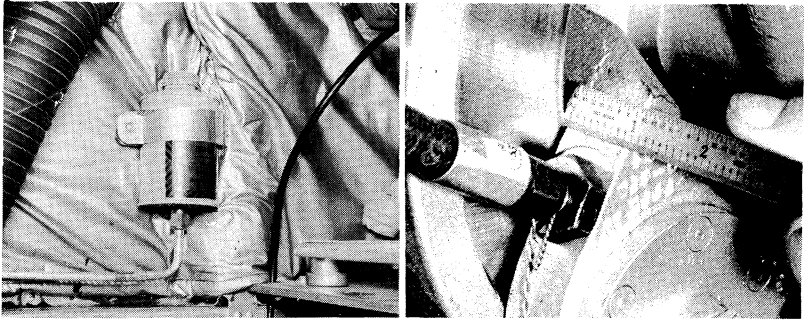

In service, the brake discs will lose their green (prime) color and become bright, then will assume a light straw color as the result of heat. These changes in color are normal and need not be a cause for concern. A glazed appearance of the brake linings also is normal; the glaze actually improves the effectiveness of the brakes.

SERVICING TIRES

The main wheel tires are 6-ply, 6.50 x 8 tires and require 36 pounds air pressure. The nose wheel tire is a 6-ply, 5.00 x 5 tire and requires 28 pounds air pressure. Maintaining proper tire inflation will minimize tread wear and aid in preventing tire rupture caused from running over sharp stones and ruts. When inflating tires, visually inspect them for cracks and breaks.

In service, tire carcasses grow slightly due to shock loads in landing. Normally, this growth is balanced by tread wear so there is no increase in tire diameter. However, if a full tread is applied in recapping a tire, the diameter may be greater than a new tire. Since clearances in the wheel well when the gear is retracted are not large, if you install recapped tires, have a retraction test made before the airplane is flown.

Oil and other hydrocarbons spilled on tires not only weaken the rubber but may cause it to swell. Avoid spilling oil, fuel or solvents on the tires and clean off any accidental spillage as soon as possible.

SERVICING THE AIR CONDITIONER

The water supply in the air conditioner wick box is sufficient for

two to four hours of operation, depending on the temperature and humidity of the outside air.

Fill the air conditioner by opening the air scoop and pouring in demineralized water until it flows from the drain line. In cold weather, when the air conditioner will not be in operation, the drain valve should be left open to allow condensed moisture to drain off and prevent freezing and breaking of the wicks.

At least twice a year the system should be drained and flushed to remove dirt and pollen that has washed in from the airstream. If operation of the air conditioner has been normal, it is not necessary to remove the wicks; however, if tap water has been used continuously, the drain and wicks may be filled with mineral deposits, which will reduce their efficiency; wicks clogged with such deposits should be replaced. This operation should be performed by a Certified Service Station.

HEAT AND VENT SYSTEM MAINTENANCE

The cabin heater ignition unit is equipped with two sets of points; if one set of points fail, a toggle switch located under the left sub-panel may be positioned to place the alternate contact points in service. The switch should be repositioned when the points are replaced to indicate that the alternate set of points is available.

OVERHEAT FUSE

The overheat fuse should not be replaced until a thorough inspection of the system has determined the cause of its blowing and the malfunction has been corrected.

HEATER FUEL PUMP

After every 25 hours of heater operation, remove the heater fuel pump strainer by turning the base of the pump counterclockwise. Wash the strainer in clean unleaded gasoline and dry with compressed air.

HEATER FUEL FILTER

A fuel filter is installed in the nose wheel well next to the heater fuel pump and filters foreign matter from the fuel. The strainer is equipped with a snap-type drain and should be drained daily

during cold weather to remove accumulated moisture which, if allowed to freeze, could cause heater malfunction.

IRIS VALVE

Lubricate the iris valve at the blower inlet occasionally with MIL-L-7866 molybdenum disulfide, never with oil or any liquid lubricant, which will collect dust.

PITOT AND STATIC SYSTEM MAINTENANCE

Clean foreign matter from the pitot plumbing by disconnecting the pitot line at the airspeed indicator and pitot mast and carefully blowing dry low pressure air through the line. Remove the pitot mast to connect the source of air pressure. After blowing the line clear, check the base connections in the system to see that they have not been disturbed.

Clean the static lines by blowing low pressure air through the lines from the disconnected line at the airspeed indicator to the static ports. Also disconnect the section of line running from the airspeed indicator to the altimeter, to the rate of climb indicator. Cover each static port separately when blowing, to insure that each line is clear. Instrument error or possible damage could result if one or both ports are clogged with dirt or foreign matter. Drain the static air line by opening the access door in the rear baggage compartment and removing the section of rubber hose.

Static air buttons should be kept free of all foreign matter including wax and polish. The exposed surface of the buttons should be cleaned periodically with Stoddard Solvent, Federal Specification P-S-661A to remove any existing film.

The vacuum-operated gyros are fitted with individual air filters, located in the back side of each instrument case, to remove dust, grit and other foreign matter from the air. The filters should be replaced after every 100 hours of operation, or oftener if the airplane is operated in dusty conditions. To replace the filters proceed as follows:

1. Remove the screws, lugs, safety wire, and snap rings attaching the filter to the instrument.
2. Remove and discard the old filter.
3. Install a new filter in the instrument.
4. Reinstall snap rings, lugs and screws, and safety wire.

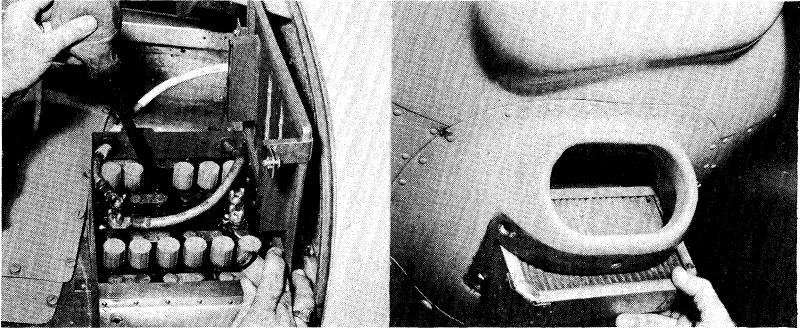

SERVICING THE BATTERY

To service the battery, open the forward utility compartment door and remove the battery box cover. Maintain the electrolyte level to cover the plates by adding distilled battery water. Avoid filling over the baffles and never fill more than $\frac{1}{4}$ inch over the separator tops. The specific gravity should be checked weekly and maintained within the limits placarded on the battery. The battery box is vented overboard to dispose of electrolyte and hydrogen gas fumes discharged during the normal charging operation. To insure the disposal of these fumes the vent hose connections at the battery box should be checked frequently for obstructions.

CARBURETOR AIR INTAKE FILTERS

To clean the carburetor air intake filters, remove from the aircraft and flush them thoroughly with cleaning solvent; if possible, use an air blast for drying and to remove excess solvent. After the filters are completely dry, saturate with clean engine oil and allow to drain before re-installation.

CLEANING

To clean your Travel Air properly, both outside and inside, follow these instructions:

EXTERIOR CLEANING

Prior to cleaning the exterior, cover the wheels, making certain the brake discs are covered; attach pitot covers securely; install plugs in, or mask off, all other openings. Be particularly careful to mask off both static air buttons before washing or waxing.

CAUTION

Do not apply wax or polish for a period of 90 days after delivery. This will give the paint a chance to cure by the natural process of oxidation. Waxes and polishes seal the paint from the air and prevent curing. If it is necessary to clean the painted surface before the expiration of the 90-day curing period, use cold or lukewarm (never hot) water and a mild soap. Never use detergents. Any rubbing of the painted surface should be done gently and held to a minimum to avoid cracking the paint film.

The airplane should be washed with a mild soap and water; loose dirt should be flushed away first, with clean water. Harsh or abrasive soaps or detergents, which could cause corrosion or make scratches, should never be used.

Soft cleaning cloths or a chamois should be used to prevent scratches when cleaning and polishing. Any ordinary automobile wax may be used to polish painted surfaces.

To remove stubborn oil and grease, use a rag dampened with naphtha.

CLEANING WINDSHIELD AND WINDOWS

Since the Plexiglass used in the windshield and windows can be very easily scratched, extreme care should be used in cleaning it. Never wipe the windshield or windows when dry. First flush the surface with clean water or a mild soap solution, then rub lightly with a grit-free soft cloth, sponge, or chamois. Use trisodium phosphate completely dissolved in water to remove oil and grease film. To remove stubborn grease and oil deposits, use hexane, naphtha, or methanol. Rinse with clean water and avoid prolonged rubbing.

After the windshield and windows are dry and free of dirt, wax them with a good grade of commercial wax to prevent scratching or crazing. Apply the wax in a thin, even coat and bring to a high polish with a clean, soft cloth.

NOTE

Do not use gasoline, benzene, acetone, carbon tetrachlo-

ride, fire extinguisher fluid, de-icing fluid, or lacquer thinners on windshield or windows as they have a tendency to soften and craze the surface.

PROPELLERS

Since propellers are subject to severe wear and atmospheric conditions, blades and hub should be periodically checked for oxidation and corrosion. Brush corroded or oxidized areas with a phosphatizing agent to remove superficial corrosion, then smooth etched and pitted areas by buffing with an aluminum polish.

Take the following precautions while cleaning propellers:

1. Be sure ignition switch is off.
2. Make sure the engine has cooled down completely. When moving the propeller, **STAND IN THE CLEAR**. There always is some danger of a cylinder firing when a propeller is moved.
3. If a liquid cleaner is used, avoid using excessive amounts because it may spatter or run down the blade and enter the hub or engine.
4. After cleaning, check the area around the hub to be sure all compound is removed.

ENGINE

The engine may be cleaned with kerosene, white furnace oil, Stoddard solvent, or any standard engine cleaning solvent. Spray or brush the solvent over the engine, then wash off with water and allow to dry. Blow excess oil off the engine with compressed air.

LANDING GEAR AND TIRES

Emulsion type cleaners are recommended for cleaning the landing gear. These solutions usually contain solvents which are injurious to rubber if allowed to remain in contact for any length of time. If these solvents come in contact with tires as a result of other cleaning operations, the solvent should be removed immediately with a thorough water rinse. To clean the tires, rinse with plain water and scrub with a brush.

WHEEL WELLS

Use a cleaning compound containing an emulsifying agent to remove oil, grease and surface dirt from the wheel wells. These

compounds, when mixed with petroleum solvents, emulsify the oil, grease and dirt. The emulsion is then removed by rinsing with water or by spraying with a petroleum solvent. Be sure to cover openings and air scoops before cleaning. If water is used as a rinse in cold weather, blow all water from the wheel well with an air hose. Water allowed to stand may freeze and lock the controls.

INTERIOR CLEANING

The seats, rugs, upholstery panels and head lining should be vacuum-cleaned frequently to remove as much surface dust and dirt as possible. Commercial foam-type cleaners or shampoos can be used to clean rugs, fabrics or upholstery. Mix a small amount of the cleaner in a bucket of water and beat the mixture to a heavy foam. After the upholstery is vacuum-cleaned, apply the foam uniformly over the surface to be cleaned and remove with a vacuum cleaner or wipe off with a brush or cloth.

Unlacquered metal fittings and furnishings can be cleaned with an ordinary commercial metal polish.

For removal of stains from any interior fabric, refer to the Stain Removal Chart.

STAIN REMOVAL CHART

NOTE

The following information covers general stain removal procedures. When solvents are specified, it is wise to test them before actually working with a stained location on the various fabrics in the Travel Air. Some of the newer fabrics react in different ways to solvents, and damage can be incurred during removal of a stain if caution is not used. When a solvent is specified, test it on a similar piece of fabric in a location that will not show before proceeding with the actual stain removal.

TYPE OF STAIN

CLEANING METHOD

Battery acid

Saturate spot with diluted solution of household ammonia. Allow to stand for one minute. Thoroughly rinse with cold water. Treat spot as soon as possible.

Blood	Rub with cold water. If some stain remains, brush with diluted household ammonia, allow to stand for one minute, and rinse with cold water. If some stain still remains, apply thick corn starch paste, allow to dry, pick off dried portion and brush surface to remove starch particles. Do not use hot water or soap.
Candy (except chocolate)	Hot water or cleaning solvent*. For cream-type candy, rub with a cloth soaked in lukewarm soap suds and scrape with a blunt tool.
Chewing gum	Moisten with cleaning solvent* and work off with a blunt tool, or hold a piece of ice against the gum and remove while still cold.
Chocolate	Remove with lukewarm water, rinse with cleaning solvent*.
Coffee	Sponge with soap and water, rinse with clean water.
Milk	Wash with soap and water, rinse with cold water.
Shoe and rubber markings	Brush with cleaning solvent*.
Tar	Moisten with cleaning solvent*, work off with blunt tool. Rinse with cleaning solvent*.
Tobacco	Sponge with alcohol, follow immediately with glycerin. Brush vigorously, rinse with water.
Fruit	Hot water or cleaning solvent*.
Grease and oil	Sponge with cleaning solvent, rub with clean cloth.
Ice cream	Hot water. If stain persists, use warm soap suds, rinse with cold water, sponge remaining stains with cleaning solvent*.
Ink	(a.) Rub Iron Rust soap into stain with fingers, allow to stand for one minute and wipe with dry cloth. Repeat as necessary. Rinse with cold water. (b.) Apply Ink Eradicator Solution No. 1 to spot with eye dropper, blot with blotting paper. Repeat as necessary. Rinse with cold water. Do not use Solution No. 2.
Lipstick	Apply cleaning solvent*, blot with blotting paper. Repeat until blotting paper no longer shows stain.
Liquor and wine	Sponge with very hot water, rub vigorously. If any stain remains, use cleaning solvent*.

*Use Perchlorethylene, Turco-Solv or Pro-Fresh cleaning solvent.

INSPECTIONS

Correct servicing being half the secret of preventive maintenance, the other half is inspection. Proper servicing will prolong the life of your Travel Air and careful, regular inspections will not only assure that servicing has been done correctly, but will disclose minor troubles so they can be corrected before they become mal-functions.

Two inspections are listed here: daily, which should be made before the first flight each day, and after 50 hours of operation. Inspections at intervals greater than 50 hours involve disassembly of the airplane and engine to various degrees and should be made only by a BEEHCRAFT Certified Service Station, where the special tools and equipment for such work, genuine BEEHCRAFT parts and factory-trained mechanics will assure you of a satisfactory job.

The 50-hour inspection should be made by a qualified mechanic, and your BEEHCRAFT Certified Service Station can best perform this operation. However, since it may be impractical occasionally to take your Travel Air to a Certified Service Station, the 50-hour inspection list has been included in this manual.

The daily, preflight inspection you should perform yourself or have it performed under your personal supervision. From the standpoint of day-to-day safety and satisfactory operation, it is the most important inspection of all. It need not be time-consuming; principally it consists of look, shake, feel and smell, and the entire inspection can be performed while you walk around the airplane once.

DAILY PRE-FLIGHT INSPECTIONS

The daily pre-flight inspection is a check of the complete airplane prior to the first flight of the day, to determine the general condition of the airplane. It duplicates in some items the pre-flight check list (walk-around) on page 36, which is intended for use before each take-off. This inspection, however, should be made in greater detail and more time should be spent on it. After the first 25 hours, give the engine a 50 hour inspection, including replacing the engine oil.

Check both POWER PLANTS to insure that:

1. Oil levels are adequate.

2. The engine has no oil leaks.
3. The carburetor and fuel lines are intact.
4. The carburetor air filter is clean.
5. Battery terminals are secure and vent hose is clear of obstructions (make electrolyte specific gravity check and capacity check every 7 days).
6. Heat and vent air inlet is not obstructed.
7. Cowling is secure and undamaged.
8. Propeller blades are not damaged.
9. Propeller is not leaking oil.

Check the AIRFRAME to insure that:

1. Fairings, panels and doors are secure and undamaged.
2. Wings, fuselage and control surfaces are not damaged.
3. Windshield is clean, inside and out.
4. General airframe skin is in good shape.
5. Trim tabs are streamlined with control surfaces, with flight and trim tab controls in neutral.
6. All access doors and inspection openings are covered and secure.
7. Static air buttons are not clogged, covered or obstructed.
8. The pitot tube is not obstructed.
9. All drain plugs and covers are properly safetied.

Check the LANDING GEAR to insure that:

1. Shock struts and tires are clean and properly inflated.
2. Landing gear safety switch is secure and undamaged.

Check the CABIN to insure that:

1. Flight control surfaces (including trim tabs) move freely and correctly respond to movements of controls.
2. Readings of fuel quantity gages correspond to known contents of the tanks.
3. Fuel selector valves and fuel booster pumps operate correctly by assuring that no pressure is indicated with pumps ON and valves OFF; and that proper pressure is indicated when valves are operated with pumps ON.
4. Cockpit lights, navigation lights, landing lights, instrument lights all work properly.
5. Engine controls operate freely and are in good condition.
6. Directional gyro and artificial horizon caging mechanisms work properly.
7. Pitot heater operates (note temperature rise of pitot head).

8. All shoulder harnesses are properly secured and the buckles work correctly.

50 HOUR INSPECTION

In addition to the daily inspection items, which should receive a more intensive check at this time, add the following items:

1. Spark plug elbows and shielding nuts are secure.
2. Priming system is checked for leaks.
3. Fuel lines are checked for leaks and wear due to rubbing or vibration.
4. Oil sumps are drained and filled with new oil after completing step 5.
5. Suction and pressure oil strainers are removed and cleaned.
6. Intake and exhaust systems are checked for leaks and looseness.
7. Fuel strainers are cleaned.
8. Gyro instrument air filters are cleaned.

STORAGE

The storage procedures listed in tabular form below are intended to protect the aircraft from deterioration while it is not in use. The primary objectives of these measures are to prevent corrosion and damage from exposure to the elements.

Three types of storage are considered: short-term, in which the aircraft is simply unused for a short period and is to be kept ready to go with the least possible preparation; long term, in which an extended period of inactivity is contemplated; and extended, in which the aircraft is actually placed on an inactive status for an indefinite time.

SHORT TERM STORAGE (Not Exceeding Two Weeks)

ITEM	PROCEDURE
Mooring	<ol style="list-style-type: none">1. If airplane cannot be placed in a hangar, tie down securely.2. Deflate nose gear strut and place support under tail to create negative angle of attack.3. Install wing spoilers consisting of fabric bags filled with fine dry sand. Place spoilers along approximately 75% of wing span.

- | | |
|--------------------------------|--|
| Engines | 1. Run up twice a week. |
| Fuel Cells | 1. Fill to capacity to minimize fuel vapor and protect cell inner liners. |
| Flight control surfaces | 1. Lock with internal and external locks. |
| Grounding | 1. Static ground airplane securely and effectively. |
| Pitot tube | 1. Install cover. |
| Windshield and windows | 1. Close all windows and window vents.
2. Install covers over windshield and windows. |

LONG TERM STORAGE (Active)

- | | |
|--------------------|---|
| Engines | <ol style="list-style-type: none"> 1. Run up twice a week or preserve as follows: <ol style="list-style-type: none"> a. Drain oil sump. b. Fill crankcase with a suitable mixture of engine lubricating oil and corrosion preventive compound. c. Warm up engine until oil temperature is normal. d. Stop engine and remove air filter. Restart engine and spray preservative oil mixture into air intake until a fog appears at exhaust outlet; stop engine while spray is still in operation. e. Remove spark plugs. Rotate propeller and spray mixture into all cylinders; spray each cylinder after stopping propeller and do not turn propeller thereafter. Coat the propeller hub and blades with a light weight oil. f. Replace spark plugs with dehydrator plugs in all cylinders. Protect cable terminals. |
| Carburetors | <ol style="list-style-type: none"> 1. No processing necessary if engines are to be run up regularly. 2. If engines are to be preserved, treat carburetors as follows: <ol style="list-style-type: none"> a. Remove fuel lines and drain all fuel from carburetor; apply 10 psi air pressure to carburetor inlet until all fuel is discharged from discharge nozzle. b. Plug fittings from which fuel lines were removed and force oil, Specification MIL-0-6081, Grade 1010 filtered through a 10-micron filter, into the carburetor fuel filter at 13 to 15 psi until oil is discharged from the discharge nozzle. |

- c. Remove plugs from fuel line fittings and replace fuel lines.

CAUTION

Do not exceed the above air and oil pressures as internal damage to the carburetor may result.

Fuel Cells

1. Fill to capacity to minimize vapor pressure and protect cell inner liners if engines are to be run up regularly.
2. If engines are to be preserved, process fuel cells as follows:
 - a. Drain fuel cells.
 - b. Flush or spray a thin coating of light engine oil on the inner liners of all fuel cells which have contained gasoline.

Instruments

1. Remove magnetic compass.

Batteries

1. Remove and store according to standard practices.

Mooring, flight control surfaces, grounding, pitot tube, windshield and windows and tires

1. See short term storage procedures.

EXTENDED STORAGE (Decommission)

Mooring

1. Follow procedure for short term storage; place support under tail when engines are removed.

Engines

1. Remove and preserve as prescribed by the manufacturer.
2. Cap all lines which were connected to engine.
3. Install dehydrator bag in nacelle.
4. Close and seal all nacelle openings.

Propellers

1. Remove and store according to standard practices.

Fuel cells

1. Drain fuel cells.
2. Flush, spray or rub a thin coating of light engine oil on the inner liners of all fuel cells which have contained gasoline.
3. After 24 hours remove cells and store according to standard practices. Do not remove or handle fuel cells until 24 hours after oil has been applied.

Flight control surfaces	<ol style="list-style-type: none"> 1. Lubricate all flight control surface hinge pins, bearings, bell cranks, chains, control rods and quadrants and coat lightly with corrosion preventive compound. 2. Lock with internal and external locks.
Grounding	<ol style="list-style-type: none"> 1. Static ground airplane securely and effectively.
Pitot tube	<ol style="list-style-type: none"> 1. Apply a thin coating of grease, Specification MIL-G-2108. 2. Install cover.
Windshield and windows	<ol style="list-style-type: none"> 1. Close all windows and window vents. 2. Install covers over windshield and windows.
Landing Gear	<ol style="list-style-type: none"> 1. Coat the extended portion of the shock struts with light weight oil.
Tires	<ol style="list-style-type: none"> 1. Install covers. 2. Check air pressure periodically; inflate as necessary.
Wing flap tracks and rollers	<ol style="list-style-type: none"> 1. Coat with corrosion preventive compound. 2. Place flaps in retracted position.
Batteries	<ol style="list-style-type: none"> 1. Remove and store according to standard practices.
Instrument panel	<ol style="list-style-type: none"> 1. Cover with barrier material and secure with tape.
Seats	<ol style="list-style-type: none"> 1. Install protective covers.
Landing lights	<ol style="list-style-type: none"> 1. Cover with barrier material and secure with tape.
Stall warning unit	<ol style="list-style-type: none"> 1. Remove and store according to standard practices. 2. Tape connections.
Loose tools and equipment	<ol style="list-style-type: none"> 1. Remove and store in a dry temperate room.
Airframe	<ol style="list-style-type: none"> 1. Cover static ports and all openings with barrier material and secure with tape to exclude rain, sun and foreign matter.



HEATER SYSTEM TROUBLE SHOOTING

TROUBLE	PROBABLE CAUSE	CORRECTION
1. Blower runs but heater will not start.	a. Blown fuse.	a. Check ductstat operation; check combustion chamber and ducts for obstructions.
	b. Faulty ignition unit vibrator.	b. Switch to reserve vibrator contacts. If this corrects trouble, replace vibrator at first opportunity.
	c. Faulty ignition unit coil.	c. Remove lead from spark plug and hold so spark may jump to structure. If no spark, repair or replace ignition unit.
	d. Faulty spark plug.	d. If test in (c) produces spark, remove and clean or replace spark plug.
	e. Fuel solenoid valve not energized.	e. Check electrical connections. Disconnect fuel line and check for fuel flow. Replace defective valve.
	f. Fuel filter clogged.	f. Clean filter.
	g. Spray nozzle clogged.	g. Clean spray nozzle.
	h. Insufficient combustion air.	h. Remove obstructions or repair leaks.

- | | | |
|---|--|---|
| 2. Heater will not shut off automatically. | a. Defective ductstat. | a. Connect voltmeter across ductstat leads and operate control. As the ductstat is pulled out, voltage should decrease. If not, replace ductstat. |
| 3. Heater backfires intermittently. | a. Loose connection in control circuit or loose ignition lead to spark plug. | a. Check electrical connections. |
| | b. Mixture too rich. | b. Make checks in item 4 below. |
| 4. Fuel mixture too rich; exhaust smudges fuselage. | a. Restriction in combustion air duct. | a. Check iris valve. Check ducts for obstructions. |
| | b. Restriction in exhaust duct. | b. Check exhaust outlet. |
| | c. Loose core in fuel nozzle. | c. Clean nozzle. Make sure core is seated tightly in shell. |

ELECTRICAL TROUBLE SHOOTING

In general, electrical troubles will fall in three classes: internal failures in the units themselves, faults in the wiring or failures in the power source. With a few exceptions, such as those components which are relay-controlled, ordinary continuity checks with a test lamp or meter should isolate these faults and the corrections then will be obvious. The troubleshooting tables given here deal with the more complex electrical systems and contain specific suggestions for isolating and correcting troubles. Certain operations, such as flashing a generator field, should be done only by qualified mechanics — preferably at a Beechcraft Certified Service Station.

TROUBLE**PROBABLE CAUSE****CORRECTION****BATTERY SYSTEM**

1. No power indicated with battery master switch on.

- a. Batteries discharged or defective.
- b. Open circuit between battery relay and master switch.
- c. Master switch defective.
- d. Defective battery relay.

- a. Test with hydrometer and voltmeter.
- b. Check continuity.
- c. Check switch for operation. Replace if necessary.
- d. Check relay for operation. Replace if necessary.

2. Power on with master switch off.

- a. Master switch defective.
- b. Battery relay contacts stuck.

- a. Check switch for operation. Replace if necessary.
- b. Replace relay.

STARTERS

1. Both starters inoperative.

- a. Circuit breaker tripped in starter switch circuit.
- b. Starter relay inoperative.
- c. Low batteries.

- a. Reset.
- b. Check continuity of starter system.
- c. Test batteries. If low, replace or start with external power.

2. One starter inoperative.

d. Loose connection or open circuit between battery positive relay and left starter relay.

a. Starter relay inoperative.

b. Poor ground at starter.

c. Open circuit.

d. Defective starting motor.

d. Check connections and continuity.

a. Check relay terminal connections and continuity of solenoid energizing circuit. If energizing circuit is closed and relay does not operate, replace relay.

b. Test continuity from armature lead to ground. Repair if necessary.

c. Check continuity to starter.

d. Check brushes, springs, condition of commutator; replace if necessary.

GENERATORS

1. No ammeter indication.

a. Engine speed too low.

b. Loose connection.

c. Open field circuit in generator; defective armature.

a. Increase speed.

b. Check connections throughout system.

c. Test resistance of field. Check field circuit connections. Replace generator if defective.

TROUBLE

PROBABLE CAUSE

CORRECTION

- | | | |
|--|---|--|
| | d. Brushes not contacting commutator. | d. Clean brushes and holders with a clean, lint-free, dry cloth. Replace weak springs. |
| | e. Brushes worn out. | e. Replace brushes if worn to a length of $\frac{1}{2}$ inch or less. |
| | f. Dirty commutator. | f. With generator running, clean commutator with No. 0000 sandpaper. Use air jet to remove grit. |
| | g. Defective voltage regulator. | g. Replace regulator. |
| | h. Defective ammeter. | h. Replace ammeter. |
| 2. No generator output. | a. Circuit breaker tripped. | a. Reset. |
| | b. Open circuit. | b. Check continuity of circuit. |
| | c. Loss of residual magnetism. | c. Flash generator field. |
| | d. Defective generator control switch or reverse current relay. | d. Test switches. Replace if defective. |
| 3. Low generator output. | a. Generators not paralleled. | a. Readjust minimum-load voltage, then readjust paralleling relay. |
| 4. Ammeter reads off scale in wrong direction. | a. Defective reverse-current relay. | a. Replace relay. |

LANDING GEAR ELECTRICAL SYSTEM TROUBLE SHOOTING

TROUBLE	PROBABLE CAUSE	CORRECTION
1. Landing gear motor fails to shut off when gear is retracted.	<ul style="list-style-type: none"> a. Up limit switch out of adjustment. b. Defective switch. 	<ul style="list-style-type: none"> a. Readjust switch. b. Replace switch.
2. Landing gear fails to retract.	<ul style="list-style-type: none"> a. Safety switch not closing b. Up limit switch remaining open. 	<ul style="list-style-type: none"> a. Readjust. b. Replace up switch.
3. Landing gear motor fails to shut off when gear is extended.	<ul style="list-style-type: none"> a. Down limit switch does not open. b. Defective down limit switch. 	<ul style="list-style-type: none"> a. Readjust limit switch. b. Replace switch.
4. Landing gear actuator is hitting internal stops.	<ul style="list-style-type: none"> a. Limit switch out of adjustment. b. Dynamic brake switch defective. 	<ul style="list-style-type: none"> a. Readjust limit switch. b. Replace.
5. Warning horn inoperative or malfunctioning.	<ul style="list-style-type: none"> a. Open or grounded circuit. b. Throttle switches inoperative. 	<ul style="list-style-type: none"> a. Check continuity. b. Check and adjust as necessary.
6. Landing gear fails to extend.	<ul style="list-style-type: none"> a. Tripped circuit breaker. b. Down limit switch open. c. Open circuit. 	<ul style="list-style-type: none"> a. Reset circuit breaker. b. Check down limit switch. With the gear retracted the down limit switch should be closed. c. Run a continuity check on the down limit switch.
7. Landing gear will not retract or extend.	<ul style="list-style-type: none"> a. Bad electrical connections. b. Landing gear motor not grounded. c. Defective control circuit. 	<ul style="list-style-type: none"> a. Run a continuity check from circuit breaker to switch. Inspect the dynamic brake relay. b. Check motor ground. c. Check items 1 through 3.

LUBRICATION POINTS

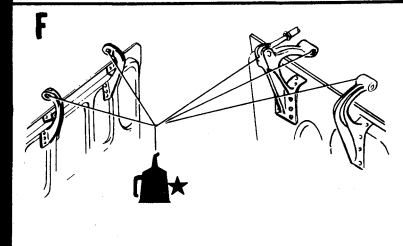
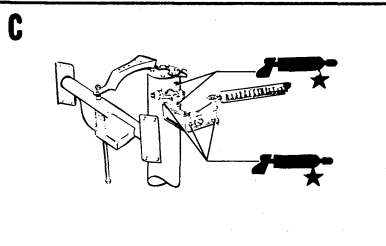
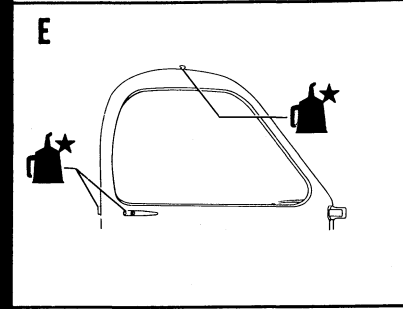
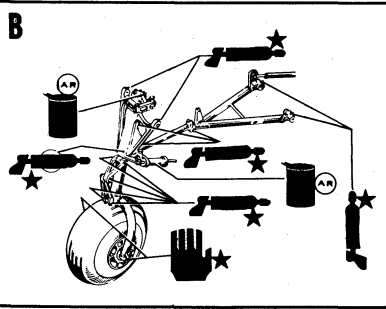
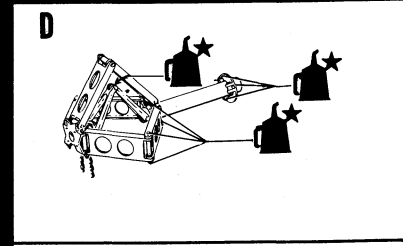
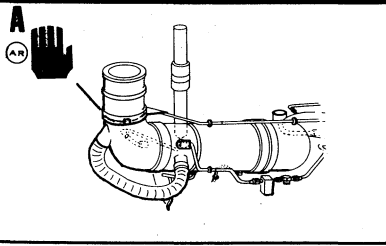
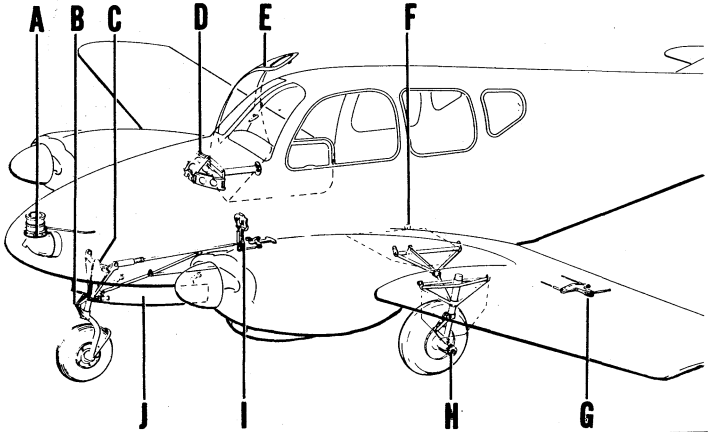

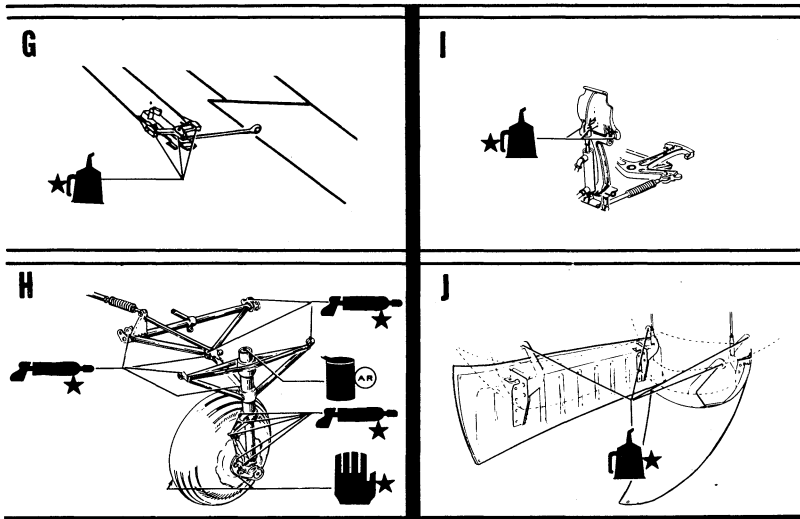

★ 100 hours

(AM) As Required



ZERK FITTING



HYDRAULIC FLUID



HAND OR PACK



SQUIRT CAN

ITEM	LOCATION	LUBRICANT	INTERVAL
DETAIL A	Ventilation air intake valve (1)	MIL-M-7866A	AR
DETAIL B	Nose shock strut (1)	MIL-O-5606	AR
	Shimmy dampener (1)	MIL-O-5606	AR
	Nose gear hinge points (2)	MIL-L-7711	100 Hr.
	Nose gear linkage (3)	MIL-L-7711	100 Hr.
	Nose gear torque knee (6)	MIL-L-7711	100 Hr.
	Nose wheel bearings (2)	MIL-L-3545	100 Hr.
	Nose gear swivel (2)	MIL-L-7711	100 Hr.
DETAIL C	Steering mechanism linkage (3)	MIL-L-7711	100 Hr.
	Steering mechanism (2)	MIL-L-7711	100 Hr.
DETAIL D	Control column linkage (6)	SAE No. 20	100 Hr.
	Control column head (3)	SAE No. 20	100 Hr.
	Control column aileron links (1)	SAE No. 20	100 Hr.
DETAIL E	Door handle (2)	SAE No. 20	100 Hr.
	Door handle (1)	SAE No. 20	100 Hr.
DETAIL F	Landing gear door hinges (10)	SAE No. 20	100 Hr.
DETAIL G	Aileron control linkage (6)	SAE No. 20	100 Hr.
DETAIL H	Main shock struts (2)	MIL-O-5606	AR
	Landing gear retract links (8)	MIL-L-7711	100 Hr.
	Landing gear torque knee (12)	MIL-L-7711	100 Hr.
	Main wheel bearings (4)	MIL-L-3545	100 Hr.
DETAIL I	Rudder pedal and bellcrank (9)	SAE No. 20	100 Hr.
DETAIL J	Nose wheel door hinges (4)	SAE No. 20	100 Hr.

() Indicates number of places to lubricate.

NOTE I: MIL-L-7711 grease may be used in the place of MIL-G-3278 grease in all normal climates. In extremely cold climates, MIL-G-3278 grease may be used.

NOTE II: Landing gear components may require lubrication every 25 or 50 hours, depending on operation.

LAMP REPLACEMENT GUIDE

LOCATION	NUMBER
Wing Navigation Lights	1524
Tail Light	1203
Landing Light	4523
Cabin Dome Light	303
Overhead Instrument Light	303
Map Light	303
Tab Position Indicator Light	356
Tab Position Indicator Light	AN 3121-1819
L. G. Visual Indicator Light	95-324006-75
Compass Light	327
Stall Warning Light	AN 3121-1819
Instrument Light	327
Rotating Beacon	A-7079-24
Taxi Light	4570
Flap Position Light	AN 3121-313
Landing Gear Position Light	AN 3121-313
■ Cowl Flap Position Light	AN 3121-313
Fuel Pump Placard Light	AN 3121-1819
■ Console Light	AN 3121-1819
R. H. C. B. and Switch Panel Light	AN 3140-327
Ignition Panel Light	AN 3140-327

THIS MANUAL MUST BE KEPT IN THE AIRPLANE AT ALL TIMES

BEECH AIRCRAFT CORPORATION, WICHITA 1, KANSAS

CAA Identification

Airplane Serial

Manufactured

CAA Approved, Based on CAR 3, Normal Category

Type Certificate 3A16

MODEL 95 LANDPLANE

AIRPLANE FLIGHT MANUAL

- I. **LIMITATIONS.** The following limitations must be observed in the operation of this airplane:
- A. **Engine Limits** (Two Lycoming 0-360-A1A engines): 2700 rpm, 28.5 in. manifold pressure (180 hp) for all operations.
- B. **Fuel:** Aviation gasoline, 91/96 minimum octane. *Usable fuel*, two 25-gallon main tanks and two 17-gallon auxiliary tanks in wings. *Optional capacity:* two 25-gallon main tanks and two 31-gallon auxiliary tanks in wings. See Equipment List.
- C. **Propellers:** Two Hartzell constant-speed, full-feathering, two-blade propellers, model HC-92ZK-2 hubs with 8447-12A blades and 835-6 spinners. Pitch setting at 30-inch station: low, 14°, high 84°. Diameter 70 - 72 inches.
- D. **Power Plant Instruments:**
Oil Temperature: yellow arc, 60°F to 140°F; green arc, 140°F to 245°F; red radial, 245°F.
Oil Pressure: red radial (minimum idling) 25 psi; green arc, 65 psi to 85 psi; red radial, 85 psi.
Fuel Pressure: red radial, 0.5 psi; green arc, 0.5 psi to 5.0 psi; red radial, 5.0 psi.
Cylinder Head Temperature: green arc, 250°F to 500°F; red radial, 500°F.
Tachometer: green arc, 2000 rpm to 2700 rpm; red radial, 2700 rpm.
Manifold Pressure: green arc, 14.5 in. Hg to 28.5 in. Hg; red radial, 28.5 in. Hg.
Suction Gage: red radial, 4.4 in. Hg; green arc, 4.8 in. Hg to 5.2 in. Hg; red radial, 5.5 in. Hg.
- E. **Airspeed Limits:** (true indicated airspeed)
Never Exceed: 240 mph (208 knots) (red radial).
Caution Range: 185 mph to 240 mph (161 knots to 208 knots) (yellow arc).
Normal Operating Range: 70 mph to 185 mph (60.8 knots to 161 knots) (green arc).
Maximum Flap Extension Speed: 130 mph (113 knots).
Maximum Gear Down Speed: 150 mph (130 knots).
Maximum Design Maneuvering Speed: 160 mph (139 knots).
Design Cruising Speed: 185 mph (161 knots).
- F. **Maneuvers:** This is a normal category airplane. Acrobatic maneuvers, including spins, prohibited.
- G. **Flight Load Factors:** At design gross weight, 4000 lbs.; Maneuver - positive, 4.4 G; negative, 3.0 G. Gust - positive, 4.32 G; negative 2.32 G.
- NOTE: Use controls with caution above 160 mph (139 knots) and with extreme caution above 185 mph (161 knots).
- H. **Maximum Weight:** 4000 pounds.
- I. **Center of Gravity Limits** (gear extended):
Forward Limit - 75 inches aft of datum to gross weight of 3480.; then straight line variation to 79.4 inches aft of datum at gross weight of 4000 lbs.
Aft Limit - 83 inches aft of datum at all weights.
- J. **Placards:**
On pilot's window frame: 'This airplane must be operated as a normal category airplane in compliance with the airplane flight manual. No acrobatic maneuvers including spins approved.
'AIRSPEED LIMITATIONS Max speed with landing gear extended (normal) 150 MPH. Max speed with flaps extended (normal) 130 MPH. Max design maneuver speed 160 MPH. Min control speed single engine 84 MPH.'
On rear windows: 'Do not open in flight. Latch window before take-off.'
On pilot's storm window: 'CAUTION Do not open above 145 MPH.'
On rear window frames: 'Latch window before take-off.'

CAA Approved

June 18, 1957

Revised: October 28, 1957

Part: 95-590014-31

On inner side of glove compartment door: 'Emergency Landing Gear Instructions to Extend: Engage handle in rear of front seat and turn counterclockwise as far as possible (50 turns).'

Inside each baggage compartment door: 'Load in accordance with Airplane Flight Manual. Maximum structural capacity 270 pounds.'

Between fuel selector handles: 'Use aux tanks and crossfeed in level flight only.'

II. PROCEDURES.

A. Normal Procedures:

1. Fuel System: Separate fuel system for each engine, with suction crossfeed. Take-off and land on main tanks only, without crossfeed. In-line electric boost pumps between engines and tank selector valves may be used on any tank; use boost pumps for starting, take-off, landing and emergencies.
2. Wing Flap Settings: Take-off, 0°; landing 33°.
3. Stall Warning Indicator - A stall warning indicator sounds a warning horn (steady note) and lights a red light on the instrument panel at 4 to 6 mph above stalling speed.
4. Vacuum System: A selector valve permits checking suction at the placarded positions in the system. Automatic check valves close if either pump fails; remaining pump will operate gyro instruments.
5. Electrical System: Individual circuit breakers protect all circuits except generators, which are protected by current limiters in engine compartments. Circuit breakers are push-to-reset or pull, then push to reset except circuit breaker switches, which are reset by moving toggle to OFF then to ON.
6. Rotating Anti-Collision Beacon: Particularly at night, reflections from rotating anti-collision lights on clouds, dense haze or dust can produce optical illusions and intense vertigo. All such lights should be turned off before entering an overcast; their use may not be advisable under any instrument or limited VFR condition.

B. Emergency Procedures:

1. Single-Engine Procedure: Minimum controllable single-engine speed is 84 mph (72.6 knots); recommended minimum single-engine rate-of-climb speed is 100 mph (86 knots) (blue radial on airspeed indicator). Add power to maintain altitude and airspeed. Pull propeller lever on dead engine back through detent to feathered position (full back). To re-start, move propeller lever into governing range, then follow normal starting procedure. When unfeathering accumulator is installed, engage starter as soon as blades start to unfeather. When engine starts, operate at reduced power until operating temperatures are normal.
2. Fuel Crossfeed: Either engine may be supplied from the other engine's tanks by placing its selector valve on crossfeed and the other selector valve on the desired tank.

CAUTION: If both engines are operating and one selector is placed on crossfeed, both engines will feed from the same tank.

3. Landing Gear: To extend manually, place landing gear switch DOWN; pull landing gear circuit breaker. Engage handcrank at rear of front seat and turn counterclockwise as far as possible (approximately 50 turns). Gear cannot be retracted manually.

CAUTION: Keep handle secured in disengaged position when not in use.

III. PERFORMANCE.

ITEM		0°F	25°F	50°F	75°F	100°F
Take-off distance (ft). Distance required to take off and climb 50 feet, flaps up, full throttle, 2700 rpm. Take-off speed, 85 mph (74 knots) (TIAS)	SL	1640	1810	1980	2180	2370
	2000	1920	2130	2335	2570	2780
	4000	2310	2550	2800	3100	3350
	6000	2820	3110	3425	3760	4120
	8000	3470	3830	4290	4710	5180
Landing distance (ft). Distance required to land over 50-foot obstacle and stop. Flaps full down. Approach at 91 mph (79 knots) (TIAS)	SL	1435	1500	1550	1610	1665
	2000	1520	1585	1640	1700	1755
	4000	1605	1670	1730	1790	1845
	6000	1690	1760	1820	1880	1940
	8000	1780	1850	1910	1970	2030
Normal climb (ft/min). Normal rated power, flaps up, best rate-of-climb speed, 105 mph (91 knots) (TIAS) at SL, reduce 1.0 mph per 2000 ft. increase in altitude	SL	1478	1425	1378	1325	1278
	2000	1333	1282	1232	1182	1132
	4000	1190	1138	1088	1036	987
	6000	1045	995	941	892	842
	8000	903	853	800	745	697
Balked landing climb (ft/min). Normal rated power, flaps and gear down. Best rate-of-climb speed 80 mph (69.5 knots) (TIAS) at SL. Reduce 1.0 mph per 3000 feet increase in altitude.	SL	810	765	725	687	645
	2000	682	642	602	563	520
	4000	557	518	475	438	395
	6000	430	392	350	312	270
	8000	304	268	225	190	145
Single engine climb (ft/min). Normal rated power, flaps and gear up, prop feathered on inoperative engine. Best rate-of-climb speed 102 mph (89 knots) (TIAS) at SL. Reduce 1.0 mph per 700 feet increase in altitude.	SL	283	257	230	203	181
	2000	220	195	168	142	119
	4000	157	132	105	80	57
	6000	94	68	42	17	-5
	8000	30	5	-20	-45	-70
Stalling Speeds, Power Off.	Angle of Bank	0°	20°	40°	60°	
	Gear & Flaps Up	84 mph (73 knots)	87 mph (75.5 knots)	96 mph (93.5 knots)	119 mph (103.5 knots)	
	Gear & Flaps Down	70 mph (61 knots)	72 mph (62.5 knots)	80 mph (69.5 knots)	99 mph (86 knots)	

Maximum altitude lost during a stall is approximately 250 feet.

Approved

Virgil H. Adamson

Virgil H. Adamson
DMCR 5-3

THIS MANUAL MUST BE KEPT IN THE AIRPLANE AT ALL TIMES

BEECH AIRCRAFT CORPORATION, WICHITA 1, KANSAS

CAA Identification

Airplane Serial

Manufactured

CAA Approved, Based on CAR 3, Normal Category

Type Certificate 3A16

MODEL 95 LANDPLANE

AIRPLANE FLIGHT MANUAL

- I. **LIMITATIONS.** The following limitations must be observed in the operation of this airplane:
- A. **Engine Limits** (Two Lycoming O-360-A1A engines): 2700 rpm, 28.5 in. manifold pressure (180 hp) for all operations.
 - B. **Fuel:** Aviation gasoline, 91/96 minimum octane. *Usable fuel*, two 25-gallon main tanks and two 17-gallon auxiliary tanks in wings. *Optional capacity:* two 25-gallon main tanks and two 31-gallon auxiliary tanks in wings. See Equipment List.
 - C. **Propellers:** Two Hartzell constant-speed, full-feathering, two-blade propellers, model HC-92ZK-2 hubs with 8447-12A blades and 835-6 spinners. Pitch setting at 30-inch station: low, 14°, high 84°. Diameter 70 - 72 inches.
 - D. **Power Plant Instruments:**
 - Oil Temperature: yellow arc, 60°F to 140°F; green arc, 140°F to 245°F; red radial, 245°F.
 - Oil Pressure: red radial (minimum idling) 25 psi; green arc, 65 psi to 85 psi; red radial, 85 psi.
 - Fuel Pressure: red radial, 0.5 psi; green arc, 0.5 psi to 5.0 psi; red radial, 5.0 psi.
 - Cylinder Head Temperature: green arc, 200°F to 500°F; red radial, 500°F.
 - Tachometer: green arc, 2000 rpm to 2700 rpm; red radial, 2700 rpm.
 - Manifold Pressure: green arc, 14.5 in. Hg to 28.5 in. Hg; red radial, 28.5 in. Hg.
 - Suction Gauge: red radial, 4.4 in. Hg; green arc, 4.8 in. Hg to 5.2 in. Hg; red radial, 5.5 in. Hg.
 - E. **Airspeed Limits:** (true indicated airspeed)
 - Never Exceed: 240 mph (208 knots) (red radial).
 - Caution Range: 185 mph to 240 mph (161 knots to 208 knots) (yellow arc).
 - Normal Operating Range: 70 mph to 185 mph (60.8 knots to 161 knots) (green arc).
 - Maximum Flap Extension Speed: 130 mph (113 knots).
 - Maximum Gear Down Speed: 150 mph (130 knots).
 - Maximum Design Maneuvering Speed: 160 mph (139 knots).
 - Design Cruising Speed: 185 mph (161 knots).
 - F. **Maneuvers:** This is a normal category airplane. Acrobatic maneuvers, including spins, prohibited.
 - G. **Flight Load Factors:** At design gross weight, 4000 lbs.; Maneuver - positive, 4.4 G; negative, 3.0 G. Gust - positive, 4.32 G; negative 2.32 G.

NOTE: Use controls with caution above 160 mph (139 knots) and with extreme caution above 185 mph (161 knots).
 - H. **Maximum Weight:** 4000 pounds.
 - I. **Center of Gravity Limits (gear extended):**
 - Forward Limit - 75 inches aft of datum to gross weight of 3480.; then straight line variation to 79.4 inches aft of datum at gross weight of 4000 lbs.
 - Aft Limit - 83 inches aft of datum at all weights.
 - J. **Placards:**
 - On pilot's window frame: 'This airplane must be operated as a normal category airplane in compliance with the airplane flight manual. No acrobatic maneuvers including spins approved. 'AIRSPEED LIMITATIONS Max speed with landing gear extended (normal) 150 MPH. Max speed with flaps extended (normal) 130 MPH. Max design maneuver speed 160 MPH. Min control speed single engine 84 MPH.'
 - On rear windows: 'Do not open in flight.'
 - On pilot's storm window: 'CAUTION Do not open above 145 MPH.'
 - On rear window frames: 'Latch window before take-off.'

CAA Approved

June 18, 1957

Revised: February 17, 1958

Part: 95-590014-33

On inner side of glove compartment door: 'Emergency Landing Gear Instructions to Extend: Engage handle in rear of front seat and turn counterclockwise as far as possible (50 turns).'

Inside each baggage compartment door: 'Load in accordance with Airplane Flight Manual. Maximum structural capacity 270 pounds.'

Between fuel selector handles: 'Use aux tanks and crossfeed in level flight only.'

II. PROCEDURES.

A. Normal Procedures:

1. Fuel System: Separate fuel system for each engine, with suction crossfeed. Take-off and land on main tanks only, without crossfeed. In-line electric boost pumps between engines and tank selector valves may be used on any tank; use boost pumps for starting, take-off, landing and emergencies.
2. Wing Flap Settings: Take-off, 0°; landing 33°.
3. Stall Warning Indicator - A stall warning indicator sounds a warning horn (steady note) and lights a red light on the instrument panel at 4 to 6 mph above stalling speed.
4. Vacuum System: A selector valve permits checking suction at the placarded positions in the system. Automatic check valves close if either pump fails; remaining pump will operate gyro instruments.
5. Electrical System: Individual circuit breakers protect all circuits except generators, which are protected by current limiters in engine compartments. Circuit breakers are push-to-reset or pull, then push to reset except circuit breaker switches, which are reset by moving toggle to OFF then to ON.
6. Rotating Anti-Collision Beacon: Particularly at night, reflections from rotating anti-collision lights on clouds, dense haze or dust can produce optical illusions and intense vertigo. All such lights should be turned off before entering an overcast; their use may not be advisable under any instrument or limited VFR condition.

B. Emergency Procedures:

1. Single-Engine Procedure: Minimum controllable single-engine speed is 84 mph (72.6 knots); recommended minimum single-engine rate-of-climb speed is 100 mph (86 knots) (blue radial on airspeed indicator). Add power to maintain altitude and airspeed. Pull propeller lever on dead engine back through detent to feathered position (full back). To re-start, move propeller lever into governing range, then follow normal starting procedure. When unfeathering accumulator is installed, engage starter as soon as blades start to unfeather. When engine starts, operate at reduced power until operating temperatures are normal.
2. Fuel Crossfeed: Either engine may be supplied from the other engine's tanks by placing its selector valve on crossfeed and the other selector valve on the desired tank.

CAUTION: If both engines are operating and one selector is placed on crossfeed, both engines will feed from the same tank.

3. Landing Gear: To extend manually, place landing gear switch DOWN; pull landing gear circuit breaker. Engage handcrank at rear of front seat and turn counterclockwise as far as possible (approximately 50 turns). Gear cannot be retracted manually.

CAUTION: Keep handle secured in disengaged position when not in use.

III. PERFORMANCE.

ITEM		0°F	25°F	50°F	75°F	100°F
Take-off distance (ft). Distance required to take off and climb 50 feet, flaps up, full throttle, 2700 rpm. Take-off speed, 85 mph (74 knots) (TIAS)	SL	1640	1810	1980	2180	2370
	2000	1920	2130	2335	2570	2780
	4000	2310	2550	2800	3100	3350
	6000	2820	3110	3425	3760	4120
	8000	3470	3830	4290	4710	5180
Landing distance (ft). Distance required to land over 50-foot obstacle and stop. Flaps full down. Approach at 91 mph (79 knots) (TIAS)	SL	1435	1500	1550	1610	1665
	2000	1520	1585	1640	1700	1755
	4000	1605	1670	1730	1790	1845
	6000	1690	1760	1820	1880	1940
	8000	1780	1850	1910	1970	2030
Normal climb (ft/min). Normal rated power, flaps up, best rate-of-climb speed, 105 mph (91 knots) (TIAS) at SL, reduce 1.0 mph per 2000 ft. increase in altitude	SL	1478	1425	1378	1325	1278
	2000	1333	1282	1232	1182	1132
	4000	1190	1138	1088	1036	987
	6000	1045	995	941	892	842
	8000	903	853	800	745	697
Balke landing climb (ft/min). Normal rated power, flaps and gear down. Best rate-of-climb speed 80 mph (69.5 knots) (TIAS) at SL. Reduce 1.0 mph per 3000 feet increase in altitude.	SL	810	765	725	687	645
	2000	682	642	602	563	520
	4000	557	518	475	438	395
	6000	430	392	350	312	270
	8000	304	268	225	190	145
Single engine climb (ft/min). Normal rated power, flaps and gear up, prop feathered on inoperative engine. Best rate-of-climb speed 102 mph (89 knots) (TIAS) at SL. Reduce 1.0 mph per 700 feet increase in altitude.	SL	283	257	230	203	181
	2000	220	195	168	142	119
	4000	157	132	105	80	57
	6000	94	68	42	17	-5
	8000	30	5	-20	-45	-70

Stalling Speeds, Power Off.	Angle of Bank	0°			
		84 mph (73 knots)	87 mph (75.5 knots)	96 mph (93.5 knots)	119 mph (103.5 knots)
	Gear & Flaps Up				
	Gear & Flaps Down	70 mph (61 knots)	72 mph (62.5 knots)	80 mph (69.5 knots)	99 mph (86 knots)

Maximum altitude lost during a stall is approximately 250 feet.

Approved

Virgil H. Adamson

Virgil H. Adamson
DMCR 5-3

On inner side of glove compartment door: 'Emergency Landing Gear Instructions to Extend: Engage handle in rear of front seat and turn counterclockwise as far as possible (50 turns).'

Inside each baggage compartment door: 'Load in accordance with Airplane Flight Manual. Maximum structural capacity 270 pounds.'

Between fuel selector handles: 'Use aux tanks and crossfeed in level flight only.'

II. PROCEDURES.

A. Normal Procedures:

1. Fuel System: Separate fuel system for each engine, with suction crossfeed. Take-off and land on main tanks only, without crossfeed. In-line electric boost pumps between engines and tank selector valves may be used on any tank; use boost pumps for starting, take-off, landing and emergencies.
2. Wing Flap Settings: Take-off, 0°; landing 33°.
3. Stall Warning Indicator - A stall warning indicator sounds a warning horn (steady note) and lights a red light on the instrument panel at 4 to 6 mph above stalling speed.
4. Vacuum System: A selector valve permits checking suction at the placarded positions in the system. Automatic check valves close if either pump fails; remaining pump will operate gyro instruments.
5. Electrical System: Individual circuit breakers protect all circuits except generators, which are protected by current limiters in engine compartments. Circuit breakers are push-to-reset or pull, then push to reset except circuit breaker switches, which are reset by moving toggle to OFF then to ON.
6. Rotating Anti-Collision Beacon: Particularly at night, reflections from rotating anti-collision lights on clouds, dense haze or dust can produce optical illusions and intense vertigo. All such lights should be turned off before entering an overcast; their use may not be advisable under any instrument or limited VFR condition.

B. Emergency Procedures:

1. Single-Engine Procedure: Minimum controllable single-engine speed is 84 mph (72.6 knots); recommended minimum single-engine rate-of-climb speed is 100 mph (86 knots) (blue radial on airspeed indicator). Add power to maintain altitude and airspeed. Pull propeller lever on dead engine back through detent to feathered position (full back). To re-start, move propeller lever into governing range, then follow normal starting procedure. When unfeathering accumulator is installed, engage starter as soon as blades start to unfeather. When engine starts, operate at reduced power until operating temperatures are normal.
2. Fuel Crossfeed: Either engine may be supplied from the other engine's tanks by placing its selector valve on crossfeed and the other selector valve on the desired tank.
CAUTION: If both engines are operating and one selector is placed on crossfeed, both engines will feed from the same tank.
3. Landing Gear: To extend manually, place landing gear switch DOWN; pull landing gear circuit breaker. Engage handcrank at rear of front seat and turn counterclockwise as far as possible (approximately 50 turns). Gear cannot be retracted manually.

CAUTION: Keep handle secured in disengaged position when not in use.

III. PERFORMANCE.

ITEM		0°F	25°F	50°F	75°F	100°F
Take-off distance (ft). Distance required to take off and climb 50 feet, flaps up, full throttle, 2700 rpm. Take-off speed, 85 mph (74 knots) (TIAS)	SL	1640	1810	1980	2180	2370
	2000	1920	2130	2335	2570	2780
	4000	2310	2550	2800	3100	3350
	6000	2820	3110	3425	3760	4120
	8000	3470	3830	4290	4710	5180
Landing distance (ft). Distance required to land over 50-foot obstacle and stop. Flaps full down. Approach at 91 mph (79 knots) (TIAS)	SL	1435	1500	1550	1610	1665
	2000	1520	1585	1640	1700	1755
	4000	1605	1670	1730	1790	1845
	6000	1690	1760	1820	1880	1940
	8000	1780	1850	1910	1970	2030
Normal climb (ft/min). Normal rated power, flaps up, best rate-of-climb speed, 105 mph (91 knots) (TIAS) at SL, reduce 1.0 mph per 2000 ft. increase in altitude	SL	1478	1425	1378	1325	1278
	2000	1333	1282	1232	1182	1132
	4000	1190	1138	1088	1036	987
	6000	1045	995	941	892	842
	8000	903	853	800	745	697
Balked landing climb (ft/min). Normal rated power, flaps and gear down. Best rate-of-climb speed 80 mph (69.5 knots) (TIAS) at SL. Reduce 1.0 mph per 3000 feet increase in altitude.	SL	810	765	725	687	645
	2000	682	642	602	563	520
	4000	557	518	475	438	395
	6000	430	392	350	312	270
	8000	304	268	225	190	145
Single engine climb (ft/min). Normal rated power, flaps and gear up, prop feathered on inoperative engine. Best rate-of-climb speed 102 mph (89 knots) (TIAS) at SL. Reduce 1.0 mph per 700 feet increase in altitude.	SL	283	257	230	203	181
	2000	220	195	168	142	119
	4000	157	132	105	80	57
	6000	94	68	42	17	-5
	8000	30	5	-20	-45	-70

Stalling Speeds, Power Off.	Angle of Bank Gear & Flaps Up	0°	20°	40°	60°
		84 mph (73 knots)	87 mph (75.5 knots)	96 mph (93.5 knots)	119 mph (103.5 knots)
	Gear & Flaps Down	70 mph (61 knots)	72 mph (62.5 knots)	80 mph (69.5 knots)	99 mph (86 knots)

Maximum altitude lost during a stall is approximately 250 feet.

Approved

Virgil H. Adamson

Virgil H. Adamson
DMCR 5-3

MODEL 95 TRAVEL AIR PILOT'S CHECK LIST

Never taxi with a flat strut!

BEFORE STARTING

1. Exterior check, fuel and oil quantity and loading—Checked.
2. Parking brake—ON.
3. Battery and generator switches—ON.
4. All switches, circuit breakers and controls—Checked.
5. Cowl flaps—OPEN.
6. Fuel selector valves—On MAIN.
7. Carburetor heat—OFF.

STARTING

1. Throttles—Approximately 1/10 OPEN.
2. Propellers—High-rpm.

NOTE

Cold engine starting: Mixtures full rich; prime as required.

Hot engine starting: Mixture in idle-cut-off until cranking; do not prime.

3. Magneto switches—Both ON.
4. Fuel boost pump—ON.
5. Starter—Engage.
6. Warm-up—800 to 1300 rpm.
7. Fuel boost pump—OFF.
8. Normal readings all gages—Checked.
9. Repeat procedure for remaining engine.

BEFORE TAKE-OFF

1. Propellers—Exercised at 2200 rpm and left in high-rpm.
2. Carburetor heat—Checked.
3. Magnetos—Checked at static rpm (maximum drop, 75 rpm).
4. Trim—Set for take-off.
5. Freedom and full travel of flight controls—Checked.
6. Fuel boost pumps—ON (optional).
7. Normal readings all instruments—Checked.

BEFORE LANDING

1. Fuel selector valves—On MAIN.
2. Mixtures—Full rich.
3. Carburetor heat—As required.
4. Fuel boost pumps—ON (optional).
5. Landing gear—DOWN and Position Indicators checked.
6. Wing flaps—As desired.
7. Propellers—High-rpm.

SHUT-DOWN

1. Parking brake—ON.
2. Electrical equipment—OFF.
3. Propellers—High-rpm.
4. Throttles—Advance to approximately 1500 rpm.
5. Mixtures—Idle-cut-off.
6. Magneto switches—OFF.
7. Battery and generator switches—OFF.
8. Fuel selector valves—OFF.
9. Controls—Locked.

SINGLE-ENGINE PROCEDURE

1. Both engines—Propellers, throttles and mixtures, FULL FORWARD.
2. Maintain—Airspeed (100 mph IAS minimum), altitude if practicable.
3. Landing gear and wing flaps—UP.
4. For inoperative engine:
 - Propeller—FEATHER.
 - Mixture—Idle-cut-off.
 - Cowl flap—CLOSED.
 - Fuel selector valve—OFF.
 - Magneto switches—OFF.
 - Generator switch—OFF.
5. Power—Adjusted on good engine.
6. Trim—For single-engine flight.